

Bathroom Furniture Series

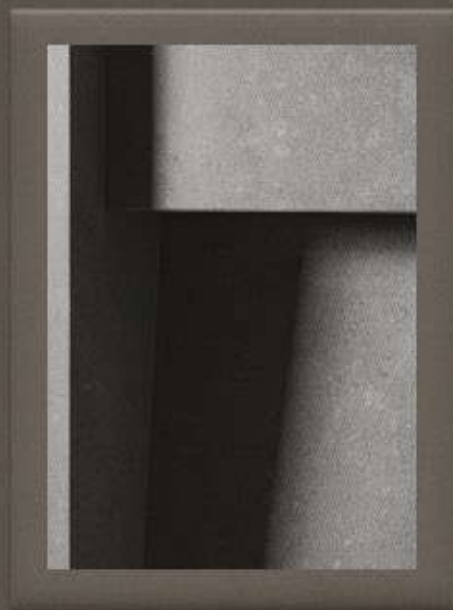

Livingceramics

A tale of
design shaped together

Hands guided by
tradition, minds inspired
by *tomorrow*

This catalogue is born from
our curiosity, restlessness, and desire
to challenge ourselves every day

All our ceramic expertise and attention to detail have been poured into a series of design bathroom proposals seeking that extra touch. Explore these pages and discover our washbasins to enhance the most personal space in your projects.

De nuestra curiosidad, de nuestro inconformismo, de nuestras ganas de retarnos cada día, nace este catálogo.

Todo nuestro saber hacer cerámico y cuidado por los detalles volcado en una serie de propuestas para baños de diseño que buscan ese plus en sus acabados. Adéntrate en estas páginas y descubre nuestros lavabos para embellecer el espacio más personal de tus proyectos.





We see *ceramics* as an extension of who we are



Our creativity flows from embracing the natural, the beauty of imperfection, respect for the earth and the purity of a material that tells its own story. Each piece is born from the inspiration that comes when design meets the human soul, free from barriers and pretension.

Entendemos la cerámica como una extensión de nuestra esencia. Nuestra creatividad fluye al abrazar lo natural, la belleza de lo imperfecto, el respeto por la tierra, la pureza de un material que cuenta su propia historia. Cada pieza nace de la inspiración que brota cuando el diseño más puro se encuentra con el alma humana, sin barreras ni pretensiones.

We innovate not only in design, but also in the way we understand the world: through human value, where together we create something greater than we could achieve alone. We are a team united by passion, as if in a collective dance. For us, every project is an opportunity to experience the beauty, togetherness and connection we are driven by.

There are no limits to the creative spirit that surrenders to the art of transforming spaces because we believe in the strength of our people and what moves us is the beauty of what we are together.

Innovamos no solo en diseño, sino en la forma de entender el mundo: desde el valor humano, donde juntos creamos algo más grande de lo que podríamos lograr solos. Somos un equipo unido por la pasión, como sumergidos en una danza colectiva. Para nosotros, cada proyecto es una oportunidad para hacer tangible la belleza, el sentido de pertenencia y la conexión que nos mueve.

No existen límites cuando el alma creativa se entrega al arte de transformar espacios, porque creemos firmemente en la fuerza de nuestra gente y lo que nos impulsa es la belleza de lo que somos juntos.

The BEAUTY of



what we
are TOGETHER



14 - 27

Milestones of Our Essence

28 - 77

Bathroom Furniture Series

78 - 93

The Architecture of Detail



Milestones
of Our Essence



The New Bathroom Furniture

Our new bathroom collection combines contemporary design with timeless elegance. This proposal includes a range of handcrafted sinks and furniture, the result of a manufacturing process that blends innovation with tradition. In this way, ceramic and wood come together as if in an endless dialogue.

With a wide variety of sizes, each piece is designed to fit naturally into any space. Our passion for ceramics and the creation of unique elements is reflected in this collection, designed to create integrated, harmonious environments full of character.

Nuestra nueva colección de baños combina diseño contemporáneo y elegancia atemporal, esta propuesta incluye una gama de lavabos y muebles de acabado manual, fruto de un proceso de fabricación que une innovación y tradición, de esta forma, cerámica y madera conversan como en un diálogo infinito.

Con una amplia variedad de formatos, cada pieza está diseñada para adaptarse con naturalidad a cualquier espacio. Nuestra pasión por la cerámica y la creación de elementos únicos se refleja en esta colección, concebida para dar forma a entornos integrados, armónicos y llenos de personalidad.

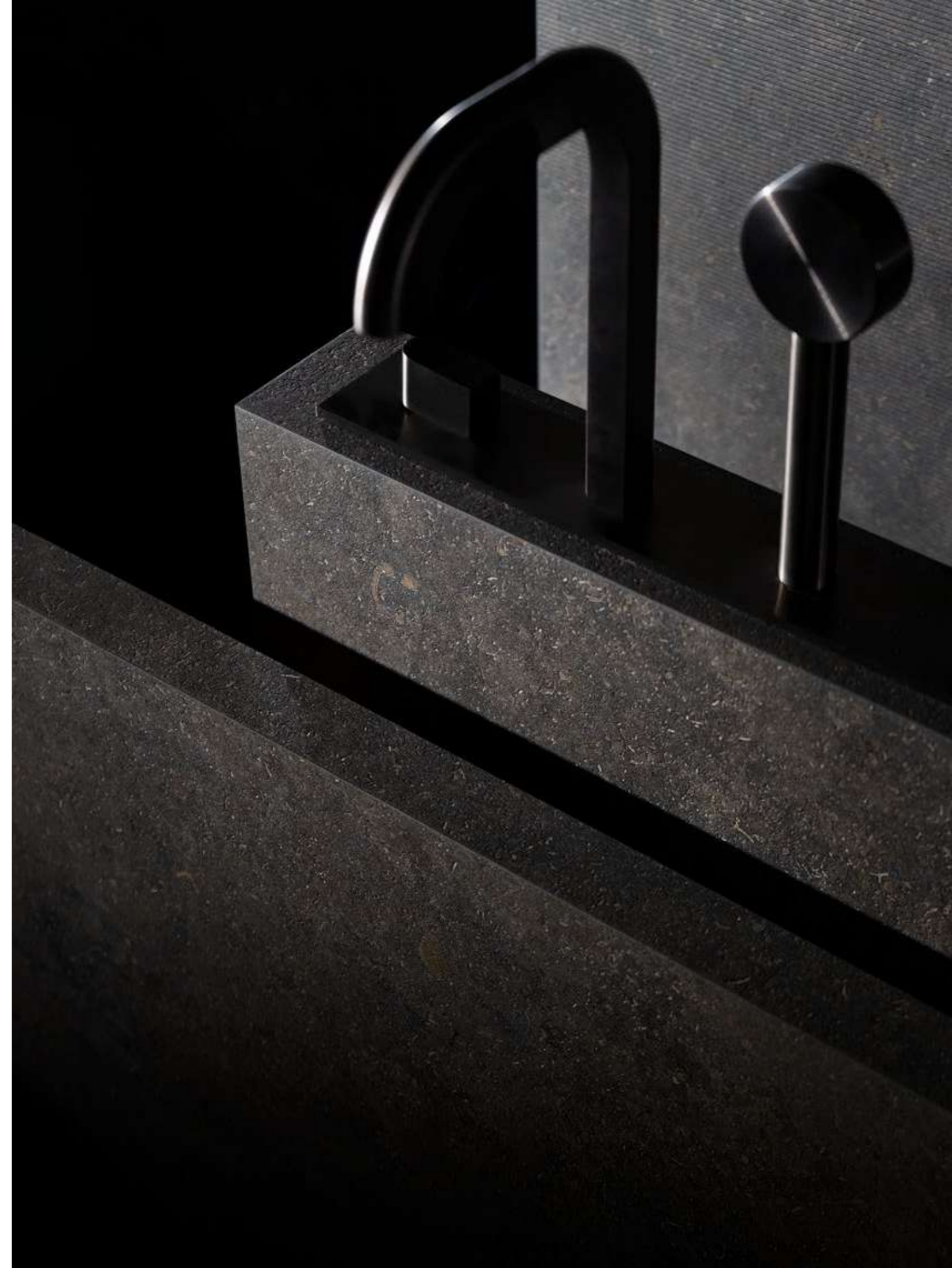



Heritage Craftmanship

Craftsmanship plays a fundamental role in the development and production of each model in this catalogue, as each piece is cut and assembled by hand to ensure a perfect fit and exact measurements. This meticulous process not only ensures quality, but also celebrates the artisan heritage that inspires our creations. Each step in the process reflects the accumulated expertise of those who master this craft, a know-how that combines precision and sensitivity. It is this dedication to perfecting every detail that transforms each model into a work of art that transcends functionality.

En el desarrollo y fabricación de cada uno de los modelos de este catálogo, la artesanía tiene un papel fundamental, ya que cada pieza se corta y ensambla de manera manual, buscando una unión perfecta y de dimensiones exactas. Este meticuloso proceso no solo garantiza la calidad, sino que también celebra el legado artesanal que inspira nuestras creaciones. Cada paso en el proceso refleja la experiencia acumulada de quienes dominan este oficio, un saber hacer que combina precisión y sensibilidad.

Es esta dedicación a perfeccionar cada detalle lo que convierte cada modelo en una obra que trasciende lo funcional para convertirse en arte.



A Guide to
the Collection



At Livingceramics we take care of every detail, every design, embedding art in its forms and balance in its composition. We strive to give each bathroom its own identity, offering freedom in the choice of finishes and the relationship between its elements, creating an infinite range of carefully studied solutions. Colours, textures, perspectives... all complement each other to create a perfect visual balance. The essence of Livingceramics is reflected in the subtlety of each model, inspired by an in-depth study of the most inspiring architectural projects and works.

En Livingceramics cuidamos cada detalle, cada diseño, plasmando el arte en sus formas y el equilibrio en su composición. Buscamos que cada baño tenga su identidad, dando libertad en la selección de acabados y en la relación entre sus elementos, creando un sinfín de soluciones cuidadosamente estudiadas. Los colores, las texturas, las perspectivas... se complementan entre sí para alcanzar un perfecto equilibrio visual.

La esencia de Livingceramics se refleja en la sutileza de cada modelo, inspirada en un profundo estudio de los proyectos y obras arquitectónicas más inspiradoras.

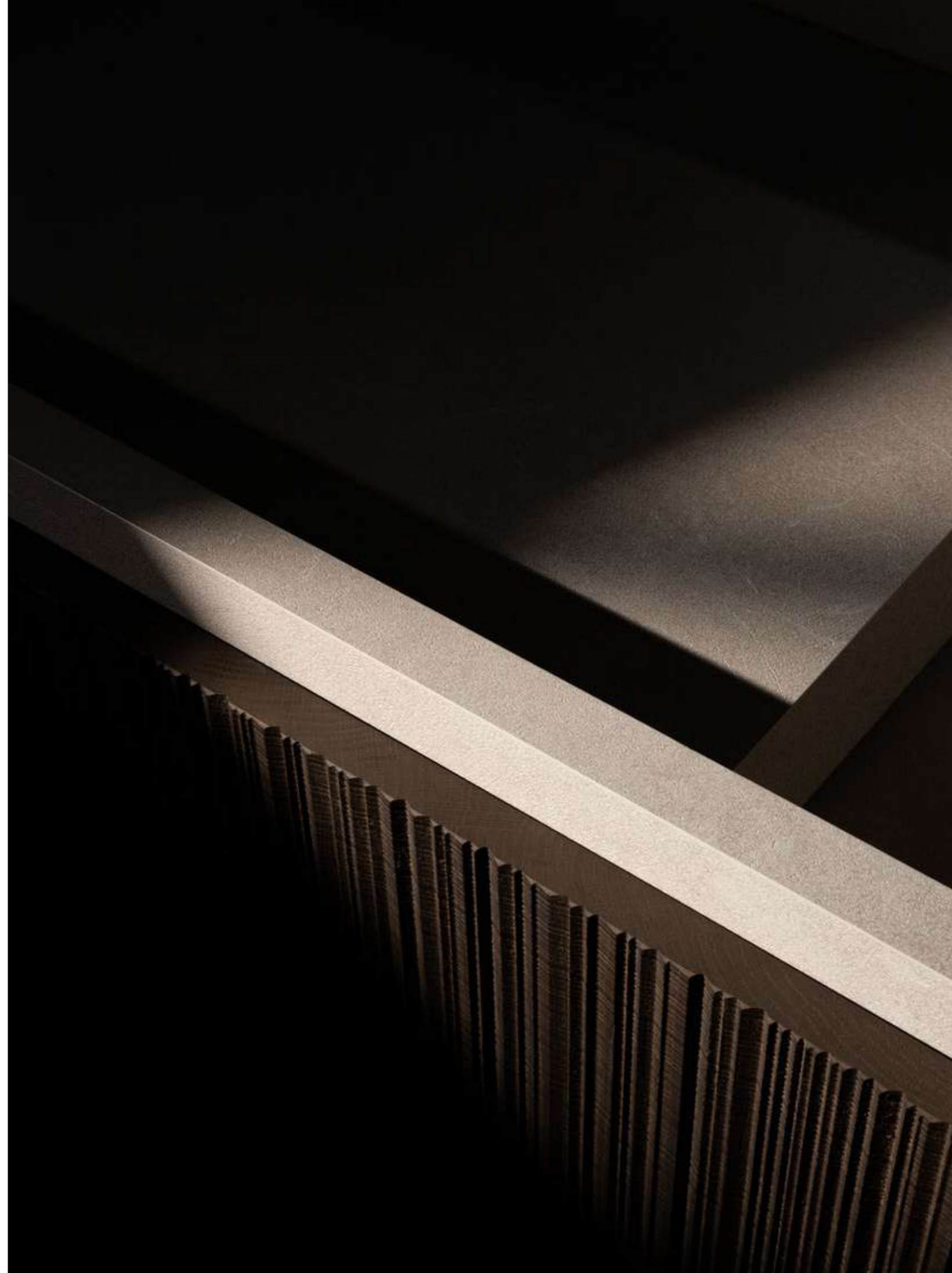

Ceramic Finishes

For Lithotech finishes, please contact us
Para acabados Lithotech, consúltenos



ALLURE
Marbled Stone in Ceramics
 Piedra Veteada Cerámica



Sand Light Grey Grey Anthracite

BERA & BEREN
Lusitan & Catalan Limestone Ceramics
 Caliza Lusitana & Catalana Cerámica



Ice White Sand Light Grey Biscuit Greige Dark Grey Black

BLANC
White Marble Stone in Ceramics
 Mármol Blanco en Cerámica



Calacatta Calacatta Gold Statuario Gold Invisible

CUIT
Mud Art in Ceramics
 Arte en Barro Cerámico



Bone Grey Clay Terra Charcoal

EME
Mediterranean Stone in Ceramics
 Piedra mediterránea Cerámica

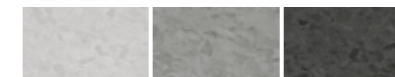

Light Grey Grey Anthracite

FLOSS
Natural Cement Ceramics
 Cemento Natural Cerámico



Bone Silver Smoky Graphite

GUBI
Microcement Ceramics
 Microcemento Cerámico



Ice Light Greige Cloud

KENDO
Jura Stone in Ceramics
 Piedra Jura en Cerámica

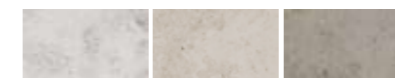

Ice Light Classic

NOON
Northern Stone in Ceramics
 Piedra del Norte Cerámica

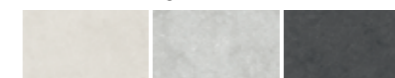

Sand Grey Anthracite

ODA
French Stone in Ceramics
 Piedra Francesa en Cerámica



Ice Light Classic

VERSO VEIN CUT
Travertine Stone in Ceramics
 Piedra Travertino en Cerámica



Light Classic Grey

VERSO CROSS CUT
Travertine Stone in Ceramics
 Piedra Travertino en Cerámica



Light Classic Grey

VOON
Textured Stone in Ceramics
 Piedra Texturada en Cerámica



Light Grey Greige Anthracite

KRON TECH *
Concrete in Tech. Porcelain
 Cemento en Porcelánico Téc.

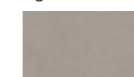

Grey

WEGA TECH *
Volcanic Stone in Tech. Porcelain
 Piedra Volcánica en Porcelánico Téc.



Black

* Available only for basins smaller than 120 cm

Bathroom
Furniture Series



Shaped by Icons, Rooted in Design

The modern style of the 20th century is synonymous with balance and elegance. It defines architectural and artistic elements in a clean and linear way, defined by the simplicity of its forms. These values are embodied in the most influential architectural buildings of this movement.

The names of the washbasins designed by Livingceramics are a reflection of these works, which is why we have used the initials of the famous architects together with the year in which they designed their iconic project for their nomenclature.

El estilo moderno del siglo XX es sinónimo de equilibrio y elegancia. Define elementos arquitectónicos y artísticos de una manera limpia y lineal, marcada por la sencillez de sus formas. Unos valores que se plasman en los diferentes edificios arquitectónicos más influyentes de este movimiento.

Los nombres de los lavabos diseñados por Livingceramics son un reflejo de estas obras, es por ello que, para su nomenclatura hemos empleado la inicial del arquitecto destacado, junto con el año en el que desarrolló su proyecto emblemático.



Inspired by:

Finlandia Hall
Alvar Aalto - 1971

The monumental forms of this renowned Finnish building were key to the development of the initial sketches for this collection. A.71 is distinguished by its functional elegance and ease of maintenance. It features a well-balanced design of geometric shapes with a hidden drain under a movable internal base. Available in lengths of 240 cm, 210 cm, 180 cm, 150 cm and 120 cm, all of which are available in two design variations to match the position of the tap, which can either be wall-mounted or integrated into the washbasin itself.

Las formas monumentales de este reconocido edificio finlandés fueron clave para desarrollar los primeros trazos de esta colección. A.71 destaca por su elegancia funcional y fácil mantenimiento. Presenta un diseño equilibrado de formas geométricas con desagüe oculto bajo una base interior móvil. Las longitudes disponibles son 240 cm, 210 cm, 180 cm, 150 cm y 120 cm, y todas ellas tienen disponibilidad de 2 variaciones de diseño adaptadas a la ubicación de la grifería, que puede ser de instalación a muro o en el mismo lavabo.





A.71 Series

A.71 [240]

With Top | Con grifo



Without Top | Sin grifo



Combine with Furnitures:

*Cabinet / *Frame / Drawer / Line
*Frame+Line
*Special Dimensions for:
A.71 [232] & Cabinet
A.71 [236] & Frame
A.71 [236] & Frame+Line

Packaging values:

Height | Altura 40 cm / 16"
Width | Anchura 275 cm / 108"
Depth | Profundidad 59 cm / 23"
Weight | Peso 169 kg

A.71 [180]

With Top | Con grifo

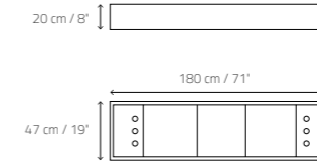

Without Top | Sin grifo

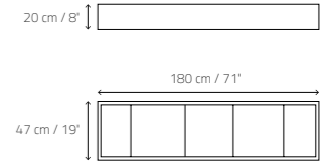

Combine with Furnitures:

*Cabinet / *Frame / Drawer / Line
*Frame+Line
*Special Dimensions for:
A.71 [172] & Cabinet
A.71 [176] & Frame
A.71 [176] & Frame+Line

Packaging values:

Height | Altura 40 cm / 16"
Width | Anchura 215 cm / 85"
Depth | Profundidad 59 cm / 23"
Weight | Peso 133 kg

A.71 [210]

With Top | Con grifo



Without Top | Sin grifo



Combine with Furnitures:

*Cabinet / *Frame / Drawer / Line
*Frame+Line
*Special Dimensions for:
A.71 [172] & Cabinet
A.71 [176] & Frame
A.71 [176] & Frame+Line

Packaging values:

Height | Altura 40 cm / 16"
Width | Anchura 247 cm / 97"
Depth | Profundidad 59 cm / 23"
Weight | Peso 155 kg

A.71 Series

A.71 [150]

With Tap | Con grifo

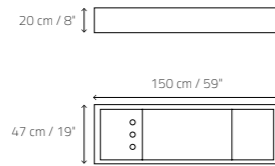

Without Tap | Sin grifo

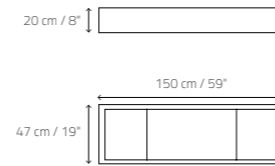

Combine with Furnitures:

*Cabinet / *Frame / Drawer / Line
*Frame+Line
*Special Dimensions for:
A.71 [112] & Cabinet
A.71 [116] & Frame
A.71 [116] & Frame+Line

Packaging values:

Height | Altura 40 cm / 16"
Width | Anchura 185 cm / 73"
Depth | Profundidad 59 cm / 23"
Weight | Peso 122 kg

A.71 [120]

With Tap | Con grifo

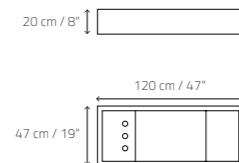

Without Tap | Sin grifo

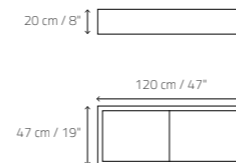

Combine with Furnitures:

*Cabinet / *Frame / Drawer / Line
*Frame+Line
*Special Dimensions for:
A.71 [112] & Cabinet
A.71 [116] & Frame
A.71 [116] & Frame+Line

Packaging values:

Height | Altura 40 cm / 16"
Width | Anchura 155 cm / 61"
Depth | Profundidad 59 cm / 23"
Weight | Peso 86 kg

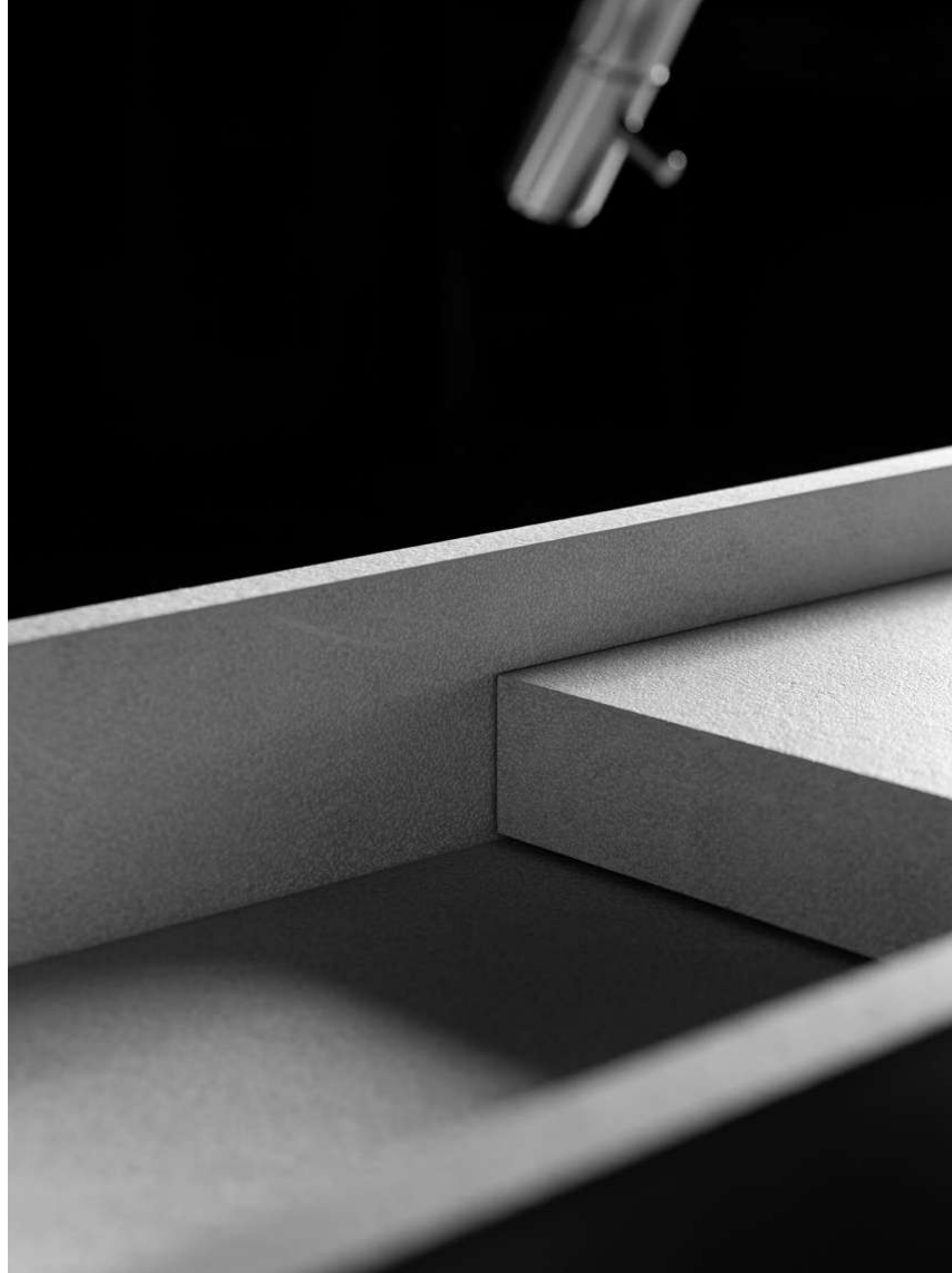



With angular lines and simple contours, L.28 features a gentle slope that starts at the very edge of the unit and an infinite slot drain. Six fixed lengths are available: 240 cm, 210 cm, 180 cm, 150 cm, 120 cm and 90 cm. The four longer designs have a central or side support area. Regardless of the version chosen, the straight lines of the basin in all models convey its simplicity.

De líneas angulosas y trazos simples, L.28 resalta por su suave pendiente, que nace en propio borde de la pieza, y un desagüe de ranura infinita. Existen seis longitudes definidas: 240 cm, 210 cm, 180 cm, 150 cm, 120 cm y 90 cm. Los cuatro diseños de dimensión mayor presentan una zona central o lateral de apoyo. Independientemente de la versión elegida, en todas ellas las formas rectas del seno transmiten su simplicidad.



L.28 Series

L.28 [240]



Combine with Furnitures:

- *Frame / Drawer / Line
- *Frame+Line
- *Special Dimensions for:
L.28 [236] & Frame
L.28 [236] & Frame+Line

Packaging values:

Height | Altura 40 cm / 16"
Width | Anchura 275 cm / 109"
Depth | Profundidad 59 cm / 23"
Weight | Peso 167 kg

L.28 [210]



Combine with Furnitures:

- *Frame / Drawer / Line
- *Frame+Line
- *Special Dimensions for:
L.28 [176] & Frame
L.28 [176] & Frame+Line

Packaging values:

Height | Altura 40 cm / 16"
Width | Anchura 247 cm / 97"
Depth | Profundidad 59 cm / 23"
Weight | Peso 154 kg

L.28 [120]

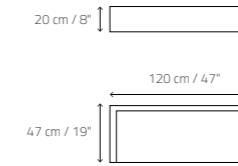

Combine with Furnitures:

- *Frame / Drawer / Line
- *Frame+Line
- *Special Dimensions for:
L.28 [116] & Frame
L.28 [116] & Frame+Line

Packaging values:

Height | Altura 40 cm / 16"
Width | Anchura 155 cm / 61"
Depth | Profundidad 59 cm / 23"
Weight | Peso 85 kg

L.28 [90]

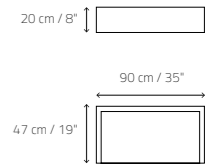

Combine with Furnitures:

- *Frame / Drawer / Line
- *Frame+Line
- *Special Dimensions for:
L.28 [86] & Frame
L.28 [86] & Frame+Line

Packaging values:

Height | Altura 46 cm / 18"
Width | Anchura 120 cm / 47"
Depth | Profundidad 80 cm / 31"
Weight | Peso 100 kg

L.28 [180]

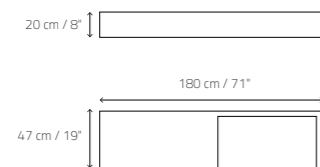

Combine with Furnitures:

- *Frame / Drawer / Line
- *Frame+Line
- *Special Dimensions for:
L.28 [176] & Frame
L.28 [176] & Frame+Line

Packaging values:

Height | Altura 40 cm / 16"
Width | Anchura 215 cm / 85"
Depth | Profundidad 59 cm / 23"
Weight | Peso 133kg

L.28 [150]

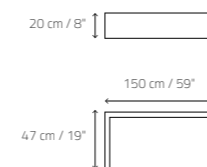

Combine with Furnitures:

- *Frame / Drawer / Line
- *Frame+Line
- *Special Dimensions for:
L.28 [86] & Frame
L.28 [86] & Frame+Line

Packaging values:

Height | Altura 40 cm / 16"
Width | Anchura 185 cm / 73"
Depth | Profundidad 59 cm / 23"
Weight | Peso 117 kg



Inspired by: Fallingwater
Frank Lloyd Wright - 1937



Inspired by one of the 20th century's most important works of residential architecture, the W.37 collection is distinguished by its large support surfaces that offer great functionality. Its unmistakable character is highlighted by the prominent basins of the washbasins, which lend it a unique and modern aesthetic. Available in 240 cm, 210 cm, 180 cm, 150 cm, 120 cm and 90 cm, the 120 cm model is asymmetrical. On the other hand, the 240 cm and 90 cm versions have a symmetrical design, emphasizing a harmonious and balanced aesthetic.

Inspirada en una de las obras arquitectónicas más destacadas del siglo XX en el ámbito residencial, la colección W.37 destaca por sus amplias superficies de apoyo, que aportan gran funcionalidad. Su carácter diferenciado se aprecia en el sobresaliente de los senos del lavabo, que aporta una estética singular y moderna. Las dimensiones disponibles son 240 cm, 210 cm, 180 cm, 150 cm, 120 cm y 90 cm, con una configuración asimétrica en los modelos de 150 cm y 120 cm. En contraste, las versiones de 240 cm, 210 cm y 90 cm presentan un diseño simétrico, que enfatiza una estética armoniosa y equilibrada.

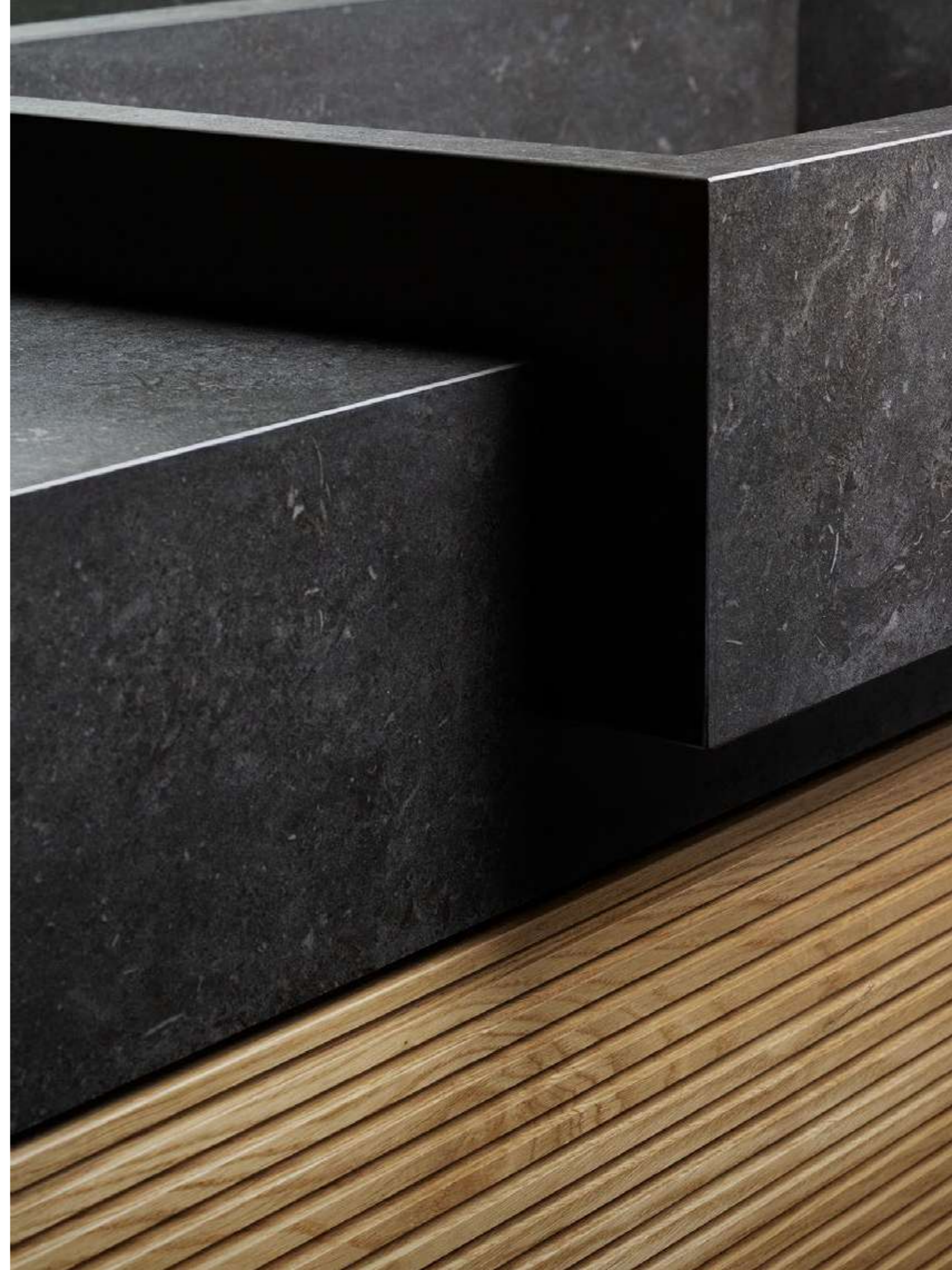

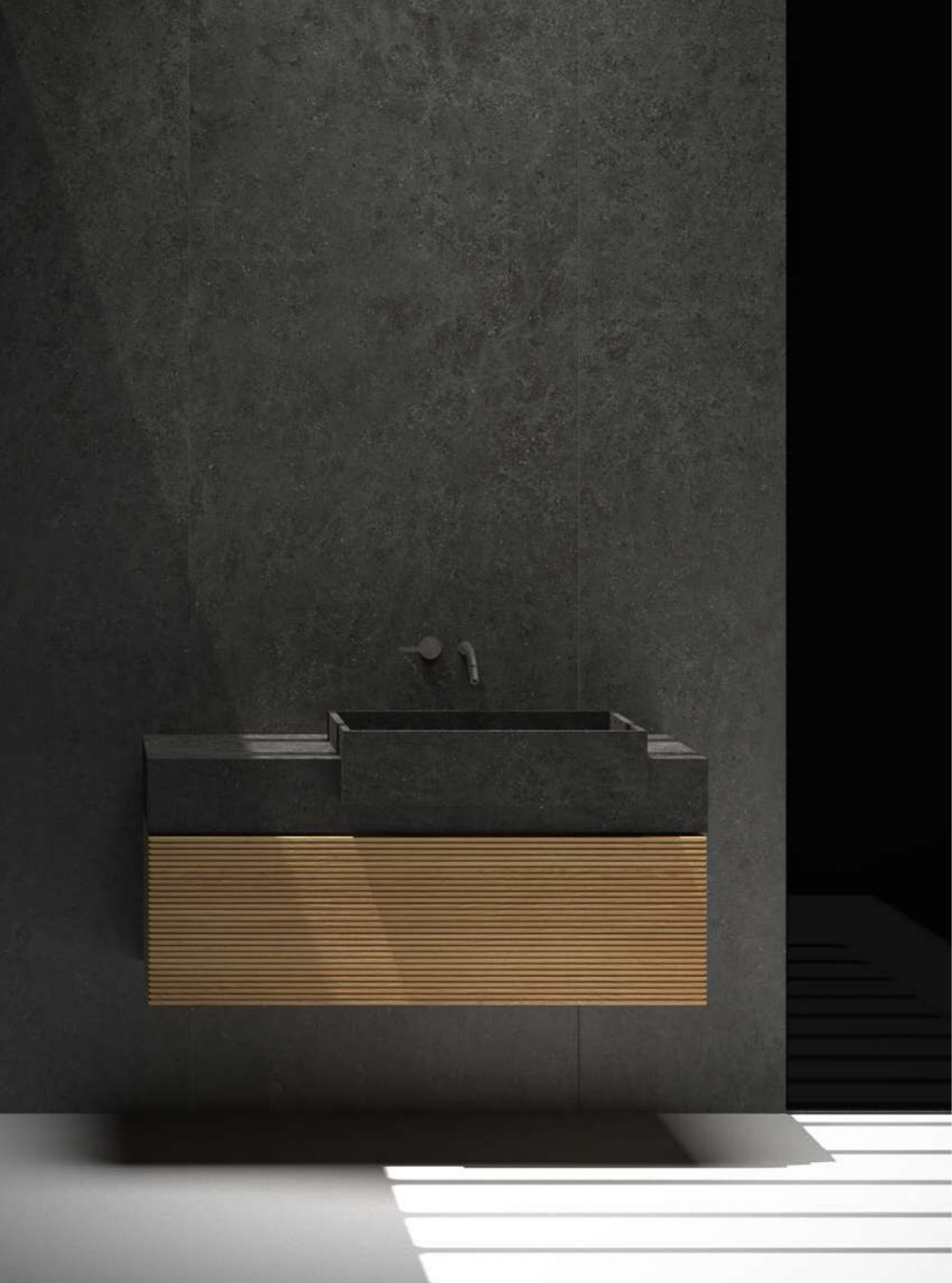

W.37 Series

W.37 [240]

With Tap | Con grifo

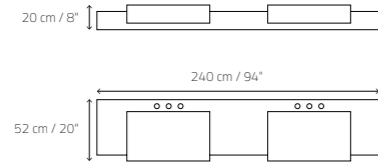

Without Tap | Sin grifo

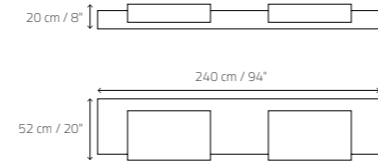

Equipped with: Accessible drain under removable piece
Desagüe accesible bajo pieza móvil

Packaging values: Height | Altura 40 cm / 16"
Width | Anchura 275 cm / 108"
Depth | Profundidad 64 cm / 25"
Weight | Peso 180 kg

Combine with Furnitures: Drawer / Line

W.37 [180]

With Tap | Con grifo

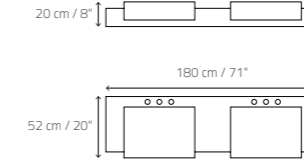

Without Tap | Sin grifo

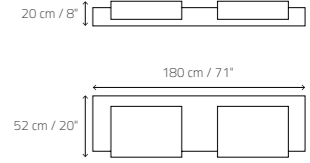

Equipped with: Accessible drain under removable piece
Desagüe accesible bajo pieza móvil

Packaging values: Height | Altura 40 cm / 16"
Width | Anchura 215 cm / 85"
Depth | Profundidad 64 cm / 25"
Weight | Peso 150 kg

Combine with Furnitures: Drawer / Line

W.37 [210]

With Tap | Con grifo

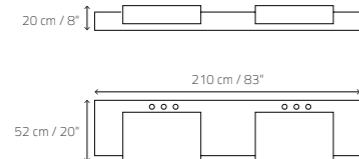

Without Tap | Sin grifo

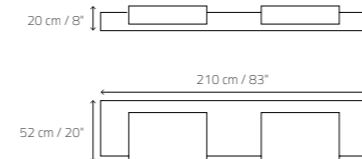
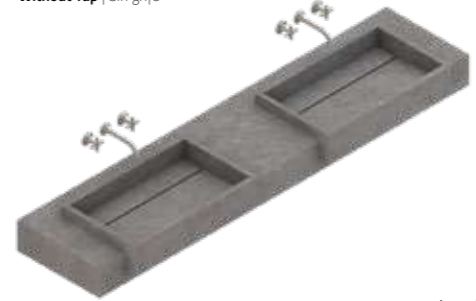

Equipped with: Accessible drain under removable piece
Desagüe accesible bajo pieza móvil

Packaging values: Height | Altura 40 cm / 16"
Width | Anchura 245 cm / 96"
Depth | Profundidad 64 cm / 25"
Weight | Peso 164 kg

Combine with Furnitures: Drawer / Line

W.37 Series

W.37 [150]

With Tap | Con grifo

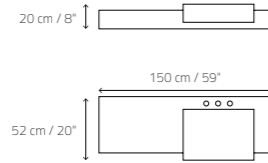

Without Tap | Sin grifo

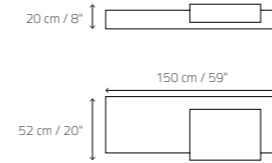

Equipped with: Accessible drain under removable piece
Desagüe accesible bajo pieza móvil

Packaging values: Height | Altura 40 cm / 16"
Width | Anchura 185 cm / 73"
Depth | Profundidad 64 cm / 25"
Weight | Peso 116 kg

Combine with Furnitures: Drawer / Line

W.37 [90]

With Tap | Con grifo

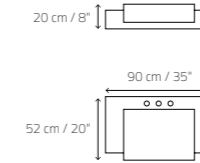

Without Tap | Sin grifo

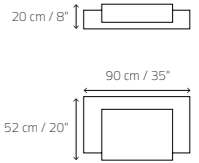

Equipped with: Accessible drain under removable piece
Desagüe accesible bajo pieza móvil

Packaging values: Height | Altura 46 cm / 18"
Width | Anchura 120 cm / 47"
Depth | Profundidad 80 cm / 31"
Weight | Peso 105 kg

Combine with Furnitures: Drawer / Line

W.37 [120]

With Tap | Con grifo

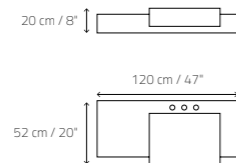

Without Tap | Sin grifo

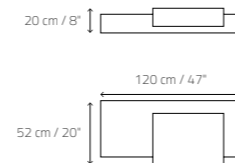

Equipped with: Accessible drain under removable piece
Desagüe accesible bajo pieza móvil

Packaging values: Height | Altura 40 cm / 16"
Width | Anchura 155 cm / 61"
Depth | Profundidad 64 cm / 25"
Weight | Peso 82 kg

Combine with Furnitures: Drawer / Line



G.19 reflects the Bauhaus philosophy with a strong functional character and practical style. It can be designed as a single piece or combined with solid oak. This versatile and timeless design is outstanding in its ability to blend naturally into any environment. The model is available with one or two basins and in eight different sizes so that its elegant design can fit into any room.

G.19 es reflejo de la filosofía Bauhaus con un fuerte carácter funcional y estilo práctico. Puede desarrollarse como una sola pieza o combinarse con madera maciza de roble. Este diseño, versátil y atemporal, destaca por su capacidad de integrarse con naturalidad en cualquier entorno.

El modelo está disponible con uno o dos senos, y en ocho diferentes medidas para adaptarse a cualquier espacio con su elegante diseño.





G.19 [240]

With Tap | Con grifo

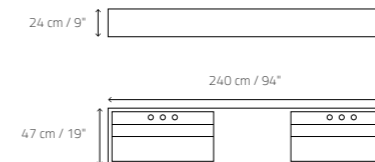

Without Tap | Sin grifo

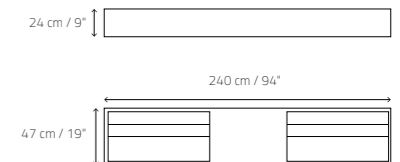

Equipped with:

Accessible drain under removable piece
Desagüe accesible bajo pieza móvil

Combine with Furnitures:

*Cabinet / *Frame / Drawer / Line
*Frame+Line
*Special Dimensions for:
G.19 [232] & Cabinet
G.19 [236] & Frame
G.19 [236] & Frame+Line

Packaging values:

Height | Altura 44 cm / 17"
Width | Anchura 275 cm / 108"
Depth | Profundidad 59 cm / 23"
Weight | Peso 190 kg

G.19 Series

G.19 [210]

With Tap | Con grifo

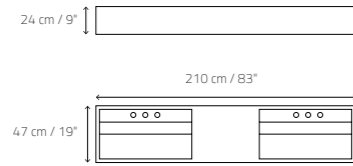

Without Tap | Sin grifo

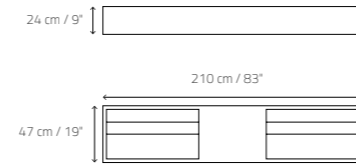
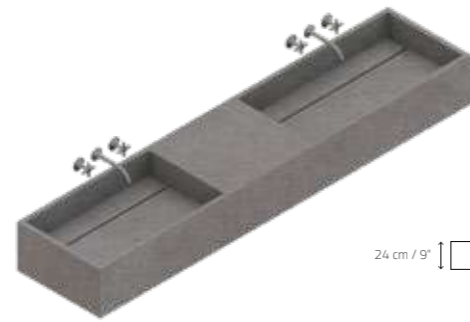

Equipped with: Accessible drain under removable piece
Desagüe accesible bajo pieza móvil

Combine with Furnitures: *Cabinet / *Frame / Drawer / Line
*Frame+Line
*Special Dimensions for:
G.19 [232] & Cabinet
G.19 [236] & Frame
G.19 [236] & Frame+Line

Packaging values: Height | Altura 44 cm / 17"
Width | Anchura 245 cm / 96"
Depth | Profundidad 59 cm / 23"
Weight | Peso 167 kg

G.19 [150]

With Tap | Con grifo

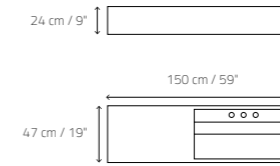

Without Tap | Sin grifo

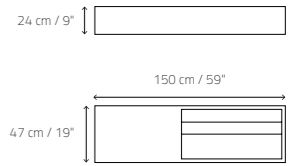

Equipped with: Accessible drain under removable piece
Desagüe accesible bajo pieza móvil

Combine with Furnitures: *Cabinet / *Frame / Drawer / Line
*Frame+Line
*Special Dimensions for:
G.19 [172] & Cabinet
G.19 [176] & Frame
G.19 [176] & Frame+Line

Packaging values: Height | Altura 44 cm / 17"
Width | Anchura 185 cm / 83"
Depth | Profundidad 59 cm / 23"
Weight | Peso 130 kg

G.19 [180]

With Tap | Con grifo

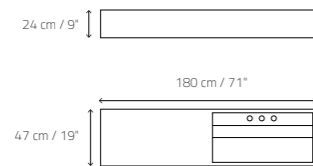

Without Tap | Sin grifo

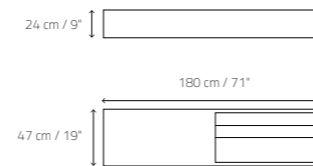

Equipped with: Accessible drain under removable piece
Desagüe accesible bajo pieza móvil

Combine with Furnitures: *Cabinet / *Frame / Drawer / Line
*Frame+Line
*Special Dimensions for:
G.19 [172] & Cabinet
G.19 [176] & Frame
G.19 [176] & Frame+Line

Packaging values: Height | Altura 44 cm / 17"
Width | Anchura 215 cm / 85"
Depth | Profundidad 59 cm / 23"
Weight | Peso 155 kg

G.19 [120]

With Tap | Con grifo

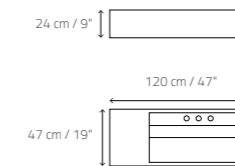

Without Tap | Sin grifo

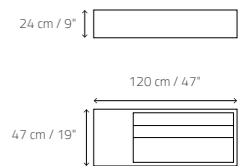

Equipped with: Accessible drain under removable piece
Desagüe accesible bajo pieza móvil

Combine with Furnitures: *Cabinet / *Frame / Drawer / Line
*Frame+Line
*Special Dimensions for:
G.19 [112] & Cabinet
G.19 [116] & Frame
G.19 [116] & Frame+Line

Packaging values: Height | Altura 44 cm / 17"
Width | Anchura 155 cm / 61"
Depth | Profundidad 59 cm / 23"
Weight | Peso 122 kg

G.19 Series

G.19 [90]

With Tap | Con grifo

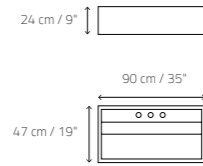

Without Tap | Sin grifo

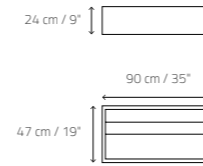

Equipped with: Accessible drain under removable piece
Desagüe accesible bajo pieza móvil

Combine with Furnitures: *Frame / Drawer / Line
*Frame+Line
*Special Dimensions for:
G.19 [86] & Frame
G.19 [86] & Frame+Line

Packaging values: Height | Altura 50 cm / 20"
Width | Anchura 120 cm / 47"
Depth | Profundidad 80 cm / 31"
Weight | Peso 110 kg

G.19 [47UN]

With Tap | Con grifo

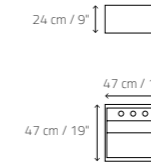

Without Tap | Sin grifo

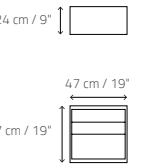

Equipped with: Accessible drain under removable piece
Desagüe accesible bajo pieza móvil

Packaging values: Height | Altura 50 cm / 20"
Width | Anchura 120 cm / 47"
Depth | Profundidad 80 cm / 31"
Weight | Peso 88 kg

* Only available with Unit Furniture
* Sólo disponible junto a Mueble Unit

G.19 [47]

With Tap | Con grifo

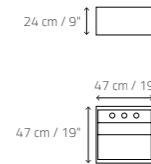

Without Tap | Sin grifo

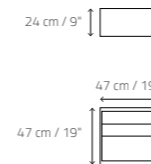

Equipped with: Accessible drain under removable piece
Desagüe accesible bajo pieza móvil

Combine with Furnitures: *Cabinet / *Frame
*Special Dimensions for:
G.19 [39] & Cabinet
G.19 [43] & Frame

Packaging values: Height | Altura 50 cm / 20"
Width | Anchura 120 cm / 47"
Depth | Profundidad 80 cm / 31"
Weight | Peso 88 kg

G.19 [47x90]

With Tap | Con grifo

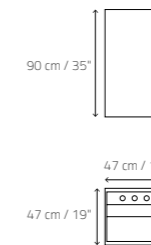

Without Tap | Sin grifo

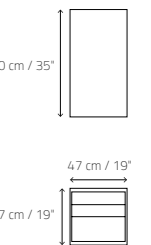

Equipped with: Accessible drain under removable piece
Desagüe accesible bajo pieza móvil

Packaging values: Height | Altura 116 cm / 46"
Width | Anchura 120 cm / 47"
Depth | Profundidad 80 cm / 31"
Weight | Peso 170 kg

Furniture
for our Basins



RIBBED
Horizontal Large Grooves
Ranuras Grandes Horizontales

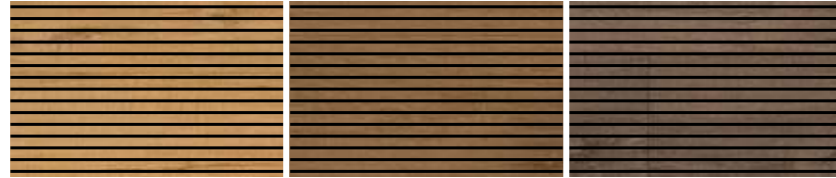

Natural Oak *

Dark Oak *

Dry Oak *

SHADOW
Vertical Slight Grooves
Ranuras Pequeñas Verticales

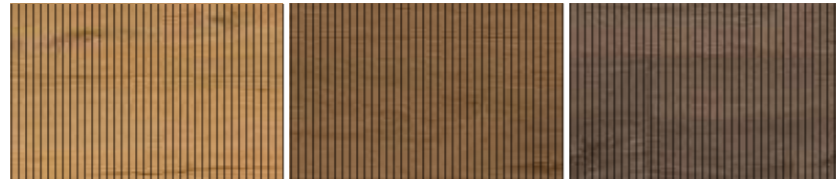

Natural Oak *

Dark Oak *

Dry Oak *

STRIPED
Horizontal Sawned Grooves
Ranuras Aserradas Horizontales



Natural Oak *

Dark Oak *

Dry Oak *

CROSS
Crossed Grooves
Ranuras Cruzadas



Natural Oak *

Dark Oak *

Dry Oak *

NATURAL OAK
Solid Natural Oak Wood
Madera maciza de roble natural



DARK OAK
Solid Natural Dark Brown Oak Wood
Madera maciza de roble marrón oscuro



DRY OAK
Solid Natural Grey Oak Wood
Madera maciza de roble gris

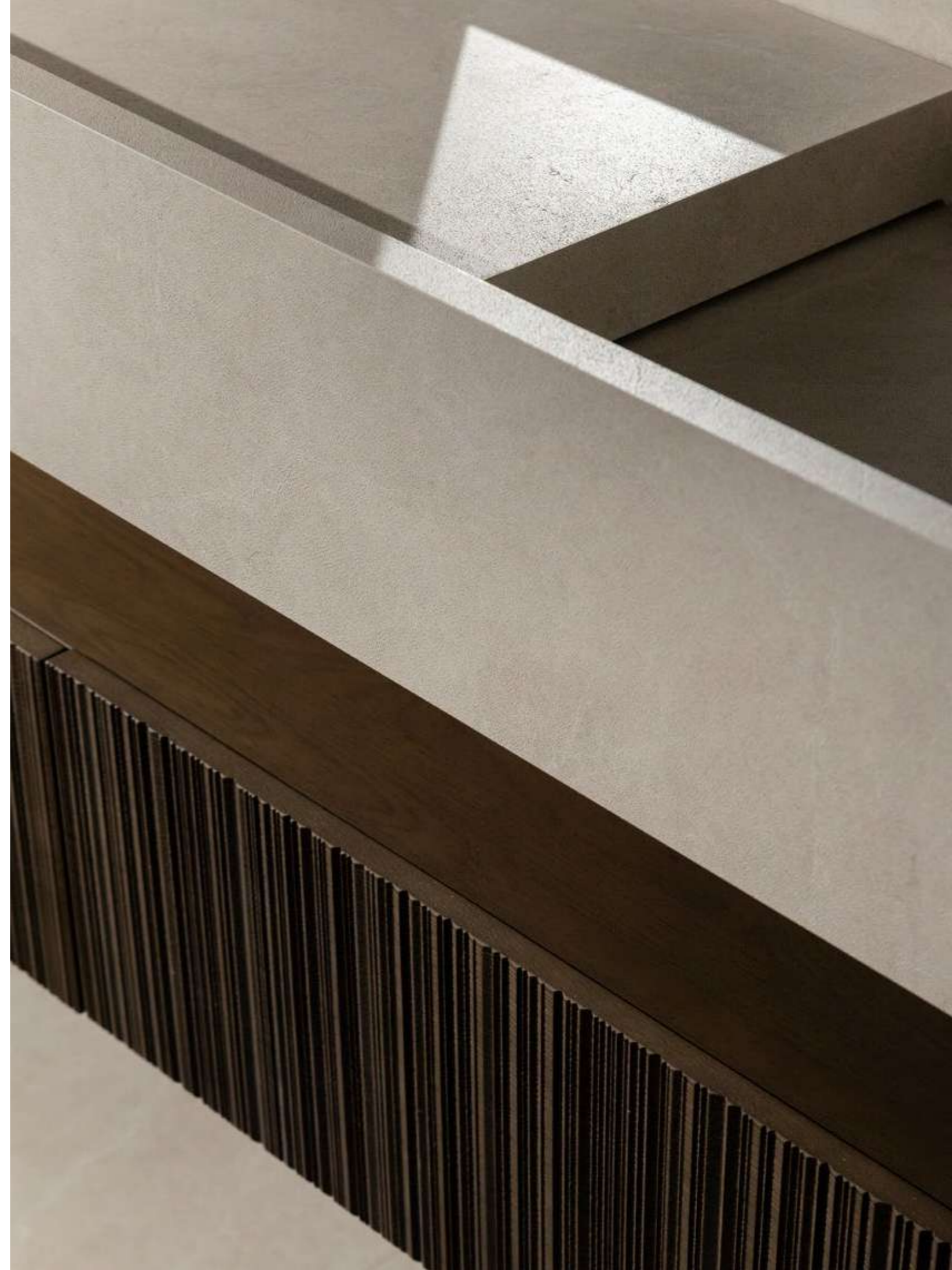



Unit

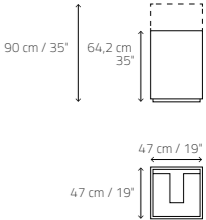
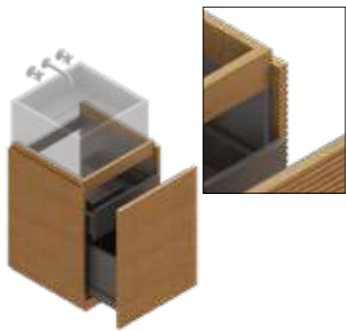

Equipped with:	2 Drawers / 2 Cajones	Packaging values:	Height Altura 75 cm / 30"
Combine with Basin:	G19 [47 UN]		Width Anchura 59 cm / 23"
Available Finishes:	Ribbed, Shadow, Striped, Cross		Depth Profundidad 57 cm / 22"
	Natural Oak Dark Oak Dry Oak		Weight Peso 109 kg

Cabinet Series

Cabinet [240]

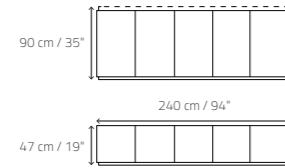

Equipped with: 10 Drawers / 10 Cajones
Combine with Basin: G19, A71

Packaging values:

Height | Altura 100 cm / 39"
Width | Anchura 262 cm / 103"
Depth | Profundidad 57 cm / 22"
Weight | Peso 125 kg

Available Finishes:

Ribbed, Shadow, Striped, Cross

■ Natural Oak ■ Dark Oak ■ Dry Oak

Cabinet [210]

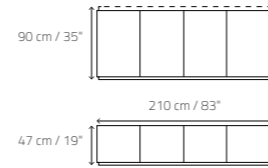

Equipped with: 4 Drawers / 4 Cajones
Combine with Basin: G19, A71

Packaging values:

Height | Altura 100 cm / 39"
Width | Anchura 222 cm / 87"
Depth | Profundidad 57 cm / 22"
Weight | Peso 116 kg

Available Finishes:

Ribbed, Shadow, Striped, Cross

■ Natural Oak ■ Dark Oak ■ Dry Oak

Cabinet [120]

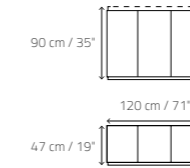

Equipped with: 6 Drawers / 6 Cajones
Combine with Basin: G19, A71

Packaging values:

Height | Altura 100 cm / 39"
Width | Anchura 132 cm / 52"
Depth | Profundidad 57 cm / 22"
Weight | Peso 65 kg

Available Finishes:

Ribbed, Shadow, Striped, Cross

■ Natural Oak ■ Dark Oak ■ Dry Oak

Cabinet [47]

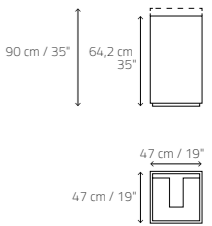
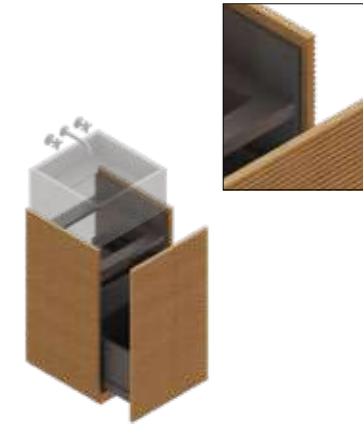

Equipped with: 2 Drawers / 2 Cajones
Combine with Basin: G19

Packaging values:

Height | Altura 107 cm / 42"
Width | Anchura 120 cm / 47"
Depth | Profundidad 80 cm / 31"
Weight | Peso 105 kg

Available Finishes:

Ribbed, Shadow, Striped, Cross

■ Natural Oak ■ Dark Oak ■ Dry Oak

Cabinet [180]

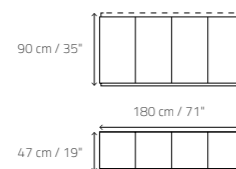

Equipped with: 8 Drawers / 8 Cajones
Combine with Basin: G19, A71

Packaging values:

Height | Altura 100 cm / 39"
Width | Anchura 192 cm / 76"
Depth | Profundidad 57 cm / 22"
Weight | Peso 97 kg

Available Finishes:

Ribbed, Shadow, Striped, Cross

■ Natural Oak ■ Dark Oak ■ Dry Oak

Cabinet [150]

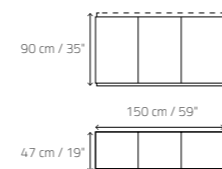

Equipped with: 3 Drawers / 3 Cajones
Combine with Basin: G19

Packaging values:

Height | Altura 100 cm / 39"
Width | Anchura 162 cm / 64"
Depth | Profundidad 57 cm / 22"
Weight | Peso 82 kg

Available Finishes:

Ribbed, Shadow, Striped, Cross

■ Natural Oak ■ Dark Oak ■ Dry Oak

Frames Series

Frame [240]

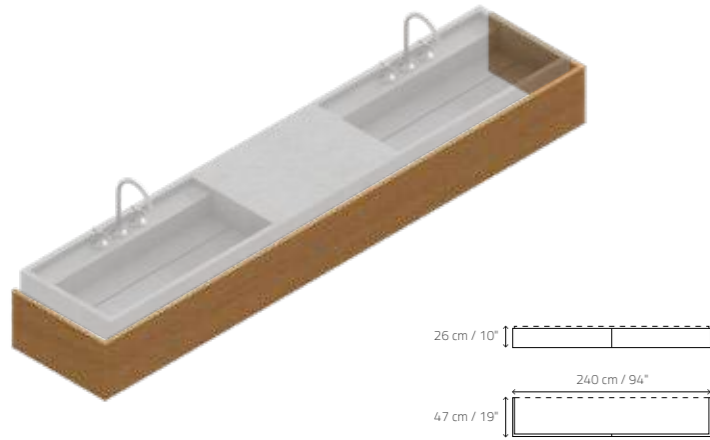

Combine with Basin: A71, L28, G19

Available Finishes:
Ribbed, Shadow, Striped, Cross

■ Natural Oak ■ Dark Oak ■ Dry Oak

Frame [210]

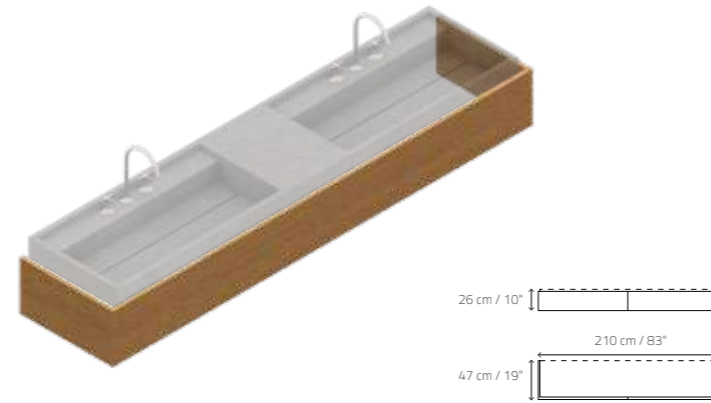

Combine with Basin: A71, L28, G19

Available Finishes:
Ribbed, Shadow, Striped, Cross

■ Natural Oak ■ Dark Oak ■ Dry Oak

Frame [120]

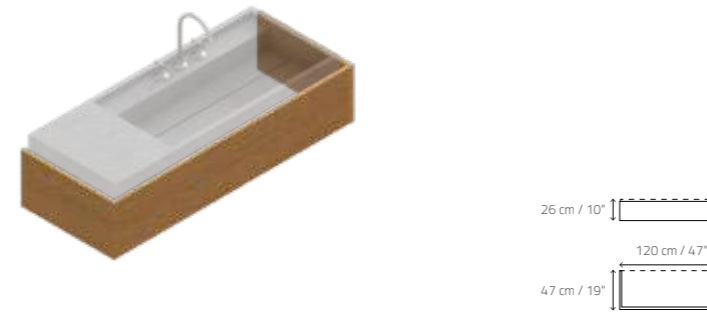

Combine with Basin: A71, L28, G19

Available Finishes:
Ribbed, Shadow, Striped, Cross

■ Natural Oak ■ Dark Oak ■ Dry Oak

Frame [90]



Combine with Basin: A71, L28, G19

Available Finishes:
Ribbed, Shadow, Striped, Cross

■ Natural Oak ■ Dark Oak ■ Dry Oak

Frame [180]

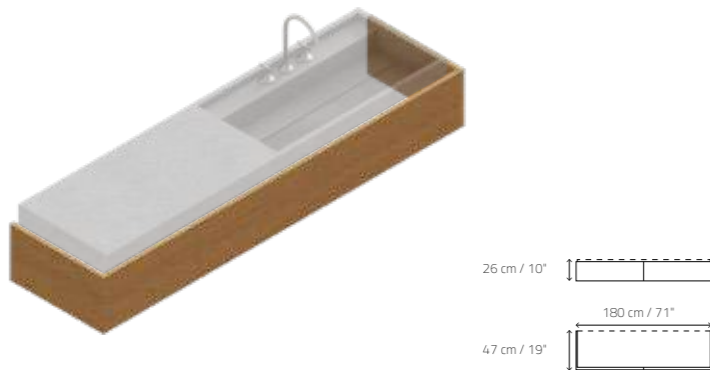

Combine with Basin: A71, L28, G19

Available Finishes:
Ribbed, Shadow, Striped, Cross

■ Natural Oak ■ Dark Oak ■ Dry Oak

Frame [150]



Combine with Basin: A71, L28, G19

Available Finishes:
Ribbed, Shadow, Striped, Cross

■ Natural Oak ■ Dark Oak ■ Dry Oak

Drawer Series

Drawer [240]

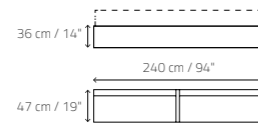
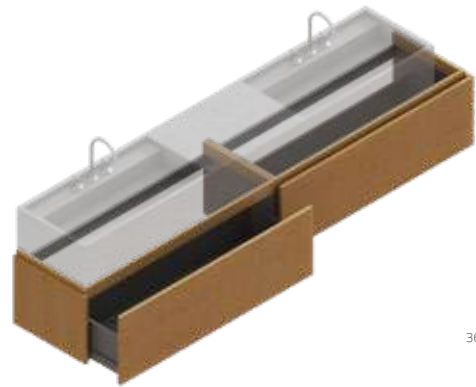

Equipped with: 2 Drawers / 2 Cajones
Combine with Basin: A71, L28, W37, G19

Packaging values:

Height | Altura 55 cm / 22"
Width | Anchura 252 cm / 99"
Depth | Profundidad 57 cm / 23"
Weight | Peso 130 kg

Available Finishes:

Ribbed, Shadow, Striped, Cross

■ Natural Oak ■ Dark Oak ■ Dry Oak

Drawer [210]

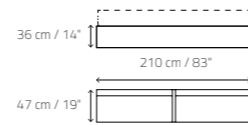

Equipped with: 2 Drawers / 2 Cajones
Combine with Basin: A71, L28, W37, G19

Packaging values:

Height | Altura 55 cm / 22"
Width | Anchura 222 cm / 87"
Depth | Profundidad 57 cm / 23"
Weight | Peso 115 kg

Available Finishes:

Ribbed, Shadow, Striped, Cross

■ Natural Oak ■ Dark Oak ■ Dry Oak

Drawer [120]

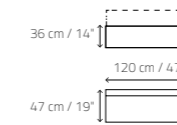

Equipped with: 1 Drawer / 1 Cajón
Combine with Basin: A71, L28, W37, G19

Packaging values:

Height | Altura 55 cm / 22"
Width | Anchura 132 cm / 52"
Depth | Profundidad 57 cm / 23"
Weight | Peso 69 kg

Available Finishes:

Ribbed, Shadow, Striped, Cross

■ Natural Oak ■ Dark Oak ■ Dry Oak

Drawer [90]

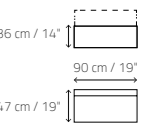

Equipped with: 1 Drawer / 1 Cajón
Combine with Basin: A71, L28, W37, G19

Packaging values:

Height | Altura 62 cm / 24"
Width | Anchura 120 cm / 47"
Depth | Profundidad 80 cm / 31"
Weight | Peso 87 kg

Available Finishes:

Ribbed, Shadow, Striped, Cross

■ Natural Oak ■ Dark Oak ■ Dry Oak

Drawer [180]

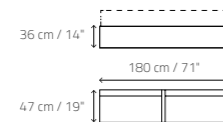
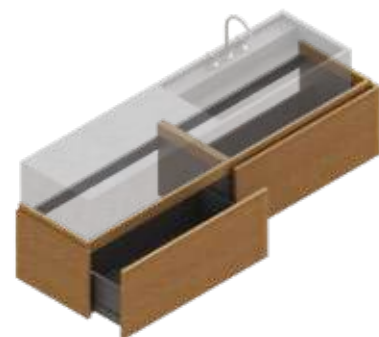

Equipped with: 2 Drawers / 2 Cajones
Combine with Basin: A71, L28, W37, G19

Packaging values:

Height | Altura 55 cm / 22"
Width | Anchura 192 cm / 76"
Depth | Profundidad 57 cm / 23"
Weight | Peso 100 kg

Available Finishes:

Ribbed, Shadow, Striped, Cross

■ Natural Oak ■ Dark Oak ■ Dry Oak

Drawer [150]

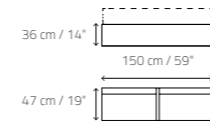

Equipped with: 2 Drawer / 2 Cajón
Combine with Basin: A71, L28, W37, G19

Packaging values:

Height | Altura 55 cm / 22"
Width | Anchura 162 cm / 64"
Depth | Profundidad 57 cm / 23"
Weight | Peso 86 kg

Available Finishes:

Ribbed, Shadow, Striped, Cross

■ Natural Oak ■ Dark Oak ■ Dry Oak

Line Series

Line [240]

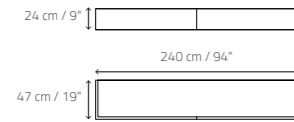

Equipped with: 2 Drawers / 2 Cajones
Combine with Basin: A71, L28, W37, G19

Packaging values:
 Height | Altura 42 cm / 17"
 Width | Anchura 252 cm / 99"
 Depth | Profundidad 57 cm / 22"
 Weight | Peso 125 kg

Available Finishes:
 Ribbed, Shadow, Striped, Cross
 Natural Oak
 Dark Oak
 Dry Oak

Line [210]

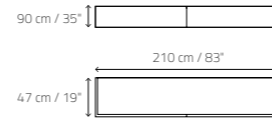

Equipped with: 2 Drawers / 2 Cajones
Combine with Basin: A71, L28, W37, G19

Packaging values:
 Height | Altura 42 cm / 17"
 Width | Anchura 222 cm / 87"
 Depth | Profundidad 57 cm / 22"
 Weight | Peso 116 kg

Available Finishes:
 Ribbed, Shadow, Striped, Cross
 Natural Oak
 Dark Oak
 Dry Oak

Line [120]

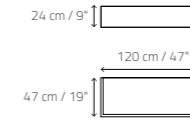

Equipped with: 1 Drawer / 1 Cajón
Combine with Basin: A71, L28, W37, G19

Packaging values:
 Height | Altura 42 cm / 17"
 Width | Anchura 132 cm / 52"
 Depth | Profundidad 57 cm / 22"
 Weight | Peso 65 kg

Available Finishes:
 Ribbed, Shadow, Striped, Cross
 Natural Oak
 Dark Oak
 Dry Oak

Line [90]

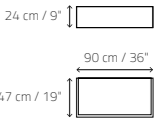

Equipped with: 1 Drawer / 1 Cajón
Combine with Basin: A71, L28, W37, G19

Packaging values:
 Height | Altura 49 cm / 19"
 Width | Anchura 120 cm / 47"
 Depth | Profundidad 80 cm / 31"
 Weight | Peso 85w kg

Available Finishes:
 Ribbed, Shadow, Striped, Cross
 Natural Oak
 Dark Oak
 Dry Oak

Line [180]

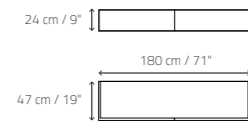

Equipped with: 2 Drawers / 2 Cajones
Combine with Basin: A71, L28, W37, G19

Packaging values:
 Height | Altura 42 cm / 17"
 Width | Anchura 192 cm / 76"
 Depth | Profundidad 57 cm / 22"
 Weight | Peso 97 kg

Available Finishes:
 Ribbed, Shadow, Striped, Cross
 Natural Oak
 Dark Oak
 Dry Oak

Line [150]

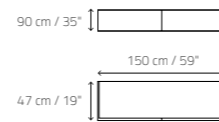









Equipped with: 2 Drawer / 2 Cajón
Combine with Basin: A71, L28, W37, G19

Packaging values:
 Height | Altura 42 cm / 17"
 Width | Anchura 162 cm / 64"
 Depth | Profundidad 57 cm / 22"
 Weight | Peso 82 kg

Available Finishes:
 Ribbed, Shadow, Striped, Cross
 Natural Oak
 Dark Oak
 Dry Oak

Combinations

		WITHOUT Furniture Sin mueble	UNIT Furniture with two interior drawers Mueble con dos cajones interiores	CABINET Cabinet with drawers Mueble con cajones	FRAME Wood cover Ferra de madera	DRAWER Chest of drawers located under the basin Cajonera situada bajo el lavabo	LINE Chest of drawers Cajonera
A.71 A.71 [240] A.71 [210] A.71 [180] A.71 [150] A.71 [120]		•					
L.28 L.28 [240] L.28 [210] L.28 [180] L.28 [150] L.28 [120] L.28 [90]		•			•	•	•
W.37 W.37 [240] W.37 [210] W.37 [180] W.37 [150] W.37 [120] W.37 [90]		•				•	•
G.19 G.19 [240] G.19 [210] G.19 [180] G.19 [150] G.19 [120] G.19 [90] G.19 [47] G.19 [47UN] G.19 [47x90]		•	•	•	•	•	•



The Architecture
of Detail





Custom Design Hub



Endless Tailor-Made Solutions

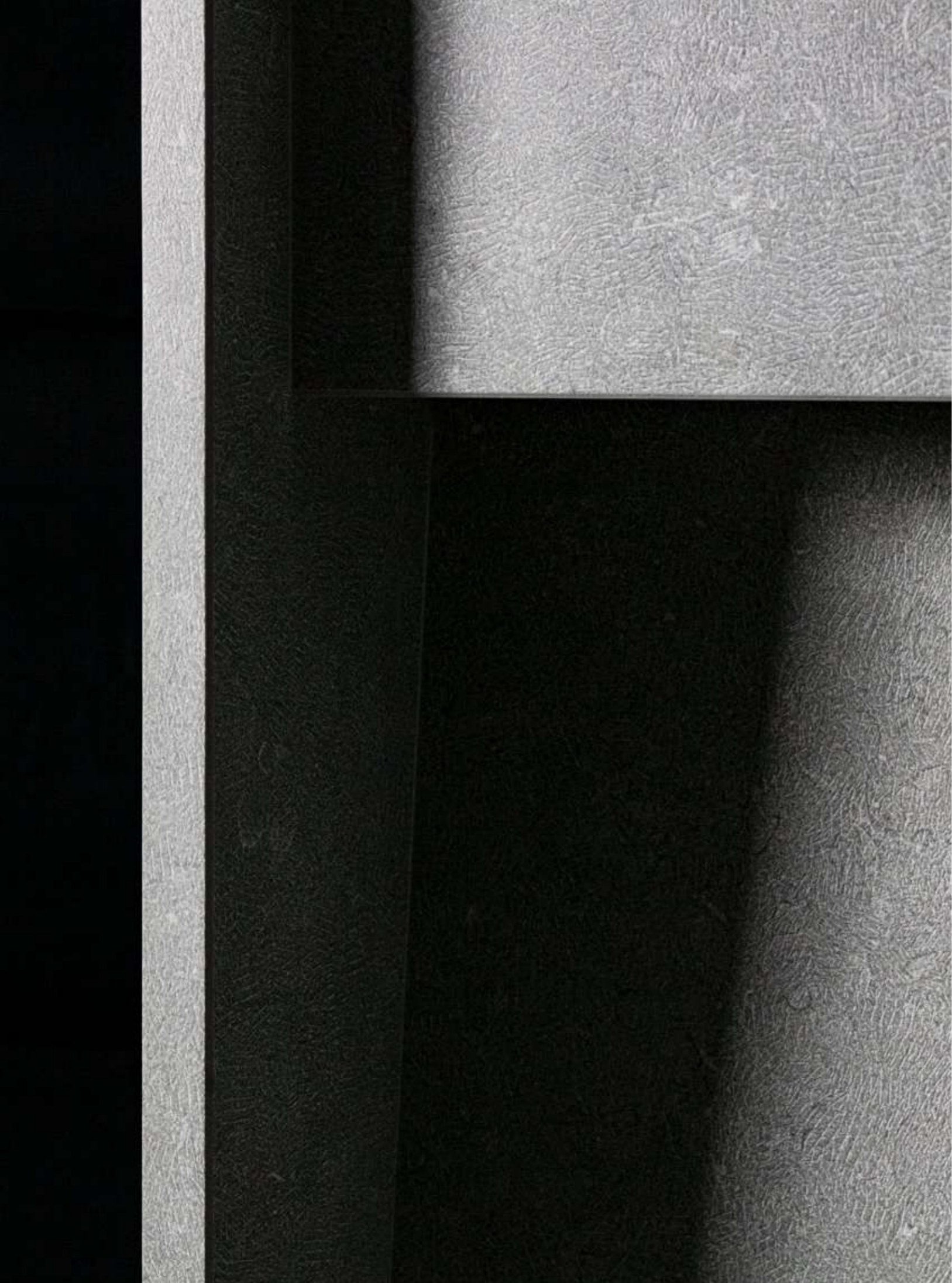

At Livingceramics, we envision ceramics as a canvas for the most ambitious ideas. This is how Custom Design Hub was born, our answer for those who seek to push the boundaries of design: a space where innovation and creative sensitivity converge to shape the extraordinary.

At Custom Design Hub, your vision takes centre stage. This space is dedicated to the design and development of bespoke pieces, created to meet the specific needs of each project. It is a place where craftsmanship and technology come together to transform ideas into reality, turning imagination into something tangible.

En Livingceramics, concebimos la cerámica como un lienzo para las ideas más ambiciosas. Así nace Custom Design Hub, nuestra respuesta a quienes buscan trascender los límites del diseño: un espacio donde la innovación y la sensibilidad creativa convergen para dar forma a lo extraordinario.

En Custom Design Hub, tu visión toma el protagonismo absoluto. Este espacio está dedicado al diseño y desarrollo de piezas únicas, concebidas para adaptarse a las necesidades específicas de cada proyecto. Es un lugar donde artesanía y tecnología se fusionan para transformar ideas en realidad, convirtiendo lo imaginado en tangible.

We redefine ceramics as an art form that combines the freedom of imagination with technological precision, transforming each line into a creation that challenges convention. None of this would be possible without the dedication of our team - a creative force that combines craftsmanship with the mastery of advanced techniques. Each project is a synergy of human talent and precision that transforms ceramics into a true statement of intent. Here, there is no limit to what is possible to achieve. Each project is a quest to capture the essence of a space and bring a vision to life, materialised through the purity of our ceramics and the collective effort of a team committed to the extraordinary.

A legacy of creativity, humanity and innovation that goes beyond ceramics.

Redefinimos la cerámica como un arte que combina la libertad de imaginar con la precisión de la tecnología, transformando cada línea trazada en una creación que desafía lo convencional. Nada de esto sería posible sin la dedicación de nuestro equipo, una fuerza creativa que fusiona la experiencia artesanal con el dominio de las técnicas más avanzadas. Cada proyecto es una sinergia de talento humano y precisión que convierte la cerámica en una auténtica declaración de intenciones. Aquí, no hay fronteras para lo posible. Cada proyecto es una búsqueda por capturar la esencia de un espacio y dar vida a una visión que se materializa gracias a la pureza de nuestras cerámicas y al esfuerzo colectivo de un equipo comprometido con lo extraordinario.

Más que cerámica, un legado de creatividad, humanidad e innovación.



Custom Design Software

Designed to be your ally in design, our Custom Design Software allows you to create bespoke pieces. Starting from an initial configurator, you can customize every detail, dimensions and finishes, until you achieve an exclusive result that reflects your vision. With our ceramic collections as allies, every detail integrates seamlessly into the space, showcasing the perfect connection between design and technology. Our 3D software is so intuitive that it effortlessly brings your ideas to life, because our goal is to help you take your projects one step further.

Pensado para ser tu aliado en el diseño, nuestro Custom Design Software te permite crear piezas a medida. Partiendo de un configurador inicial, puedes personalizar cada detalle, medidas y acabados, hasta lograr ese resultado único que refleje tu visión. Con nuestras colecciones cerámicas como aliadas, cada detalle se integra con naturalidad en el espacio, mostrando la perfecta conexión entre diseño y tecnología. Nuestro software 3D es tan intuitivo que convierte tus ideas en realidad sin esfuerzo, porque nuestro objetivo es ayudarte a llevar tus proyectos un paso más allá.

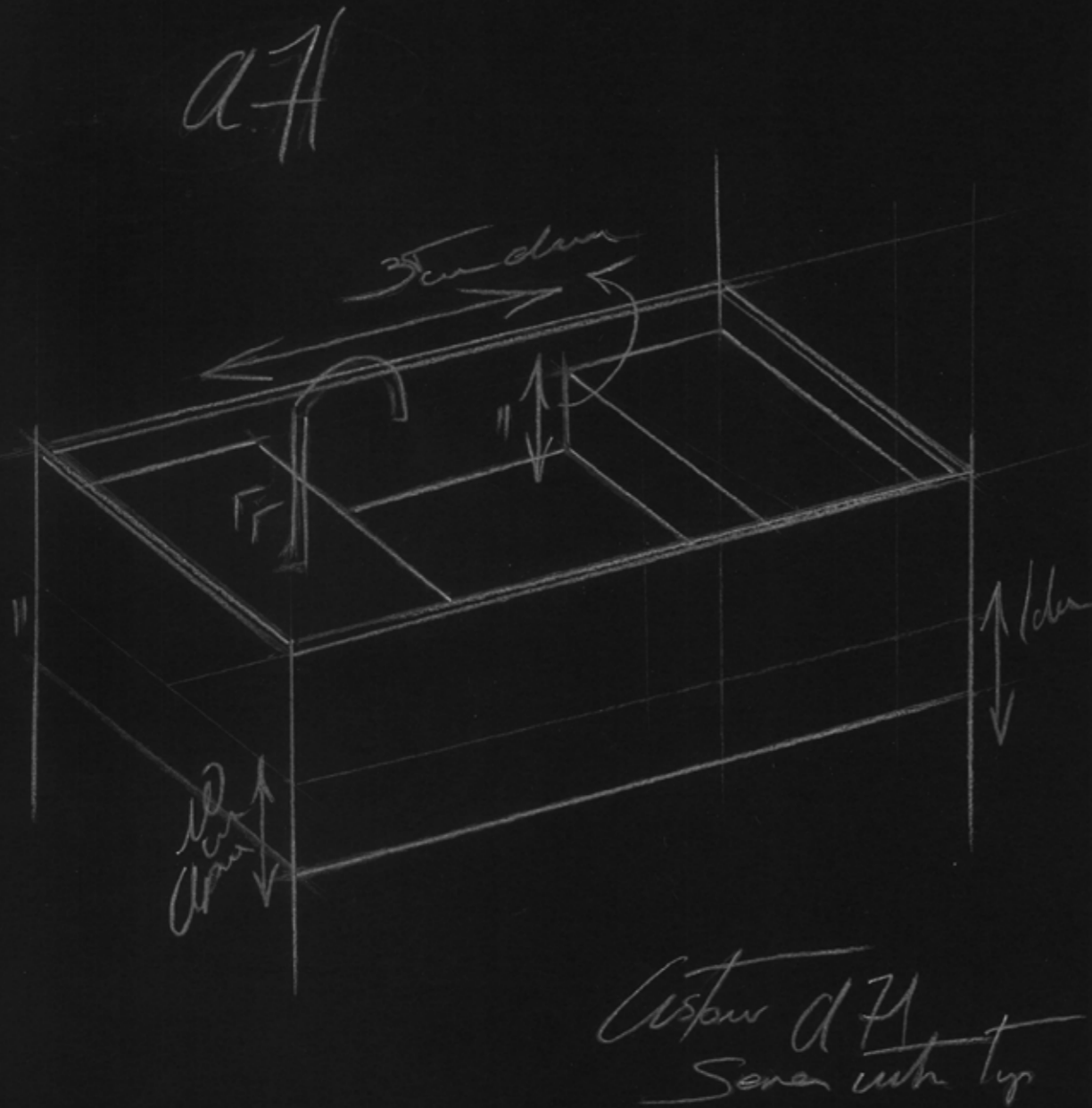

Find out on our website.



For the correct installation of bathroom furniture, it is recommended to reinforce the partition taking into account the approximate weights indicated in the technical data sheet of the corresponding furniture or sink.

Consideraciones Previas.

Para la correcta instalación de los muebles de baño, se recomienda reforzar el tabique teniendo en cuenta los pesos aproximados que se indican en la ficha técnica del correspondiente mueble o lavabo.

TECHNICAL SPECIFICATIONS & MAINTENANCE

1. WOOD

The wooden bathroom units are made of solid oak, in a smudge-proof matt lacquer finish. Real oak has a high resistance to biological agents like fungi or insects. By using solid oak, the collection is assured a unique personality, and each unit stands out for its select appearance. Because this is real wood, in the long term it can undergo subtle changes in appearance through exposure to sunlight or other external agents. Consequently, precise uniform shades and continuous veined patterns cannot be guaranteed, and the wood might feature some knots. This is regarded to be an added value, since each unit will have a slightly distinctive end appearance, a unique facet of natural materials. The interiors are made of water-repellent top-quality MDF with an Anthracite-coloured wood veneer finish, ensuring a higher resistance to surface damage. The bathroom units stand out particularly for their imperviousness and resistance when used in wet areas. This makes them the perfect choice for indoor areas.

2. CERAMIC TILES

The ceramic washbasins in this ground-breaking collection are made of top-quality porcelain tiles, an optimum choice for bathrooms. This is a forward-looking material, both technologically and in product design terms, thanks to technical properties as fundamental as its water absorption rate, durability and fire resistance. Its mechanical and thermal properties easily surpass the requirements of the relevant standards.

CARING FOR THE WASHBASINS AND BATHROOM UNITS

Ceramic washbasins and countertops, must be cleaned on a regular basis. They are swift and simple to clean, using just a moist microfibre cloth. Detergent can also be used, as per the amount indicated by the manufacturer. Take special care with all joints and follow the instructions of the manufacturer of the grouting material. To make the washbasins easier to clean, there is an opening in the underside, providing access to the channel where the drain is. This facilitates the fitting process and the cleaning of this concealed area. The drainage channel must be more carefully cleaned, using a damp cloth and, if appropriate, a detergent as described above.

To clean the wood units, use a soft moist cloth. Do not use detergent, wax, soap or other products. Dry the wood well afterwards to avoid stains or surface damage.

ESPECIFICACIONES TÉCNICAS Y MANTENIMIENTO

1. MADERA

Las piezas de mobiliario en acabado madera están fabricadas en roble macizo natural, presentando un lacado o acabado mate antihuella. La madera natural de roble presenta una alta resistencia a agentes biológicos, tales como hongos e insectos. La utilización de madera maciza confiere un carácter único a la colección, aportando un aspecto distinguido a cada pieza. Al ser una madera natural puede presentar a largo plazo una pequeña variación en su aspecto original debido a la exposición del sol u a otros agentes externos. Por este motivo, no se asegura una uniformidad precisa en las tonalidades de sus acabados, así como una continuidad en las vetas de la madera, pudiendo presentar nudos. Este aspecto se observa como un valor añadido, ya que el mueble tiene una estética final personal, característica única en los materiales naturales. El interior se fabrica con tableros de DM hidrófugo de alta calidad chapados en acabado Anthracite, asegurando una mejor resistencia con respecto a daños superficiales. Una de sus características más importantes es la impermeabilidad y resistencia a espacios húmedos, siendo un material de características óptimas para el espacio interior.

2. CERÁMICA

Los lavabos cerámicos están fabricados en gres porcelánico de primera calidad, presentando una colección innovadora utilizando un material óptimo para espacios de baño. El uso de dicho material representa un salto hacia el futuro en términos de tecnología y planificación del producto. Se consiguen unas características técnicas perfectas en cuanto a absorción del agua, durabilidad y resistencia contra el fuego. El material presenta unas propiedades mecánicas y térmicas que representan una gran mejora sustancial con respecto a los requisitos exigidos por la normativa en vigor.

MANTENIMIENTO LAVABOS Y MOBILIARIO

Los lavabos y encimeras de cerámica de la marca deben tener una limpieza continuada, la cual puede ser sencilla y rápida. Sencillamente, se puede recurrir a un paño suave de microfibra húmedo, pudiendo utilizar detergentes con la dosis recomendada por el fabricante. Hay que tener especial cuidado con las juntas, por ello se recomienda seguir las indicaciones aportadas por el distribuidor de la marca de la junta elegida. Para una correcta limpieza, se ha diseñado una apertura en la parte inferior del lavabo, a través de la cual se accede al canal donde se ubica el desagüe. De esta forma, se facilita tanto la limpieza de dicha zona oculta, además de una fácil instalación. Dicha superficie o canal debe limpiarse con más asiduidad y cuidado, mediante una bayeta húmeda y recurriendo si se desea a algún detergente como anteriormente se ha definido.

Para la limpieza de los muebles de madera, se sugiere utilizar un paño suave y húmedo, evitando el uso de detergentes, ceras, jabones u otros productos. Se debe asegurar el secado completo de la madera para no provocar manchas o daños superficiales.

Sales Conditions

THE FOLLOWING GENERAL TERMS AND CONDITIONS GOVERN SALES BETWEEN LVG Ceramic Surfaces. S.L. AND ITS CLIENTS.

1. ORDERS

The parties' obligations concerning deliveries of goods (the transfer of responsibilities, expenses, insurance, customs procedures etc.) shall be those deriving from the agreed specific terms and conditions (INCOTERMS IN FORCE). Barring possible agreed written amendments or exceptions, the general terms and conditions outlined herein shall regulate all sale agreements between our company and the buyer and hence both the contractual agreement that was reached on acceptance of this order and any future agreement for the supply of products by our company through successive different orders. Variations in the general sales conditions and in any sales offers, transactions, credit notes or discounts agreed upon by our Agents or by other intermediaries shall only be deemed to be valid once they have been accepted in writing by our head office and, in all such cases, this written acceptance shall only apply to the related agreement.

2. SUPPLIES AND DELIVERIES OF GOODS

On reception of a delivery of goods, the buyer shall immediately inspect them for flaws or defects. LVG Ceramic Surfaces. S.L. must be given written notice of any external or visible flaws within fifteen (15) days of the reception of the goods. In the case of hidden flaws, the deadline for claims shall be thirty (30) days from the reception of the goods. If no notice of any flaws is given by the buyer within the said deadlines, the latter shall be deemed to have approved the goods. The buyer of a faulty product must make a claim within the aforementioned stipulated period, opting for one of the following possible solutions:

1. The delivery of a new product in exchange for the return of the faulty one.

2. A refund of the price that was paid in exchange for the return of the faulty product.

The distributor shall be liable for attaching the warranty, technical specifications and product care instructions to the invoice given to the client.

3. RETURNS

Faulty goods must be returned in the same state and packaging in which they were received. Orders received directly from clients or placed on the latter's behalf by our representatives shall always be subject to our acceptance. The acceptance of a return by LVG Ceramic Surfaces. S.L. does not mean that it admits or agrees to the claim for the faulty product. In the event of mistakes in the number of goods that are supplied, the buyer shall only be entitled to claim for the number that was not delivered.

4. DELIVERIES

Goods delivered by LVG Ceramic Surfaces. S.L. are subject to retention of title. The ownership of the goods shall only be transferred to the buyer when they have been fully paid for. LVG Ceramic Surfaces. S.L. shall be entitled to offset any sum owed to it by the buyer against any sum payable by the company to the buyer. In the event of failure to comply with the conditions regarding the payment and/or return of the agreed goods, the buyer shall be liable for the cost of their return, plus any expenses of an administrative nature or costs derived from legal claims, including the fees of solicitors and court representatives. In the event of a delay in the payment of goods by the buyer, the seizure of the latter's goods or a substantial decline in the buyer's financial situation, LVG Ceramic Surfaces. S.L. shall be entitled to claim immediate payment of the invoiced amount, to withhold all pending supplies and services, to condition the delivery of goods—once the buyer is no longer in arrears—upon their advance payment and, if applicable, to claim for any corresponding compensation. Under no circumstances may the goods be resold through a website (online sales). Unless agreed otherwise, the buyer shall be forbidden from exporting materials supplied by LVG Ceramic Surfaces. S.L. and from making them available to companies or individuals who go on to export them.

5. COMPETENT JURISDICTION

The resulting relations between the parties shall be subject to the legislation of the Kingdom of Spain. Both parties expressly waive their right to any other corresponding jurisdiction and they agree to abide by the decisions of the Vila-real Law Courts (Castellón) in the settlement of any dispute, controversy or claim that might arise in connection with the said commercial relations.

6. DATA PROTECTION

In accordance with Spanish Data Protection Act 3/2018 of December 5th, the personal data supplied by the buyer shall be entered in LVG Ceramic Surfaces. S.L.'s client file for the purpose of managing contractual relations and controlling and managing sales and the corresponding collection of payment. LVG Ceramic Surfaces. S.L. shall process the said data with all due confidentiality and it undertakes not to use the said information for any other purpose than that cited above. Likewise, it agrees to take the necessary steps to keep the data safe and to avoid its alteration, loss, and unauthorized access or processing. The buyer shall be entitled to exercise its right of access, rectification, cancellation and objection by giving written notice to LVG Ceramic Surfaces. S.L..

LAS SIGUIENTES CONDICIONES GENERALES RIGEN LAS COMPRAVENTAS ENTRE LVG Ceramic Surfaces. S.L. Y EL CLIENTE.

1. NORMATIVA PARA LA CONTRATACIÓN

Las obligaciones de las partes en relación a la entrega de la mercancía (traspaso de responsabilidad, gastos, seguros, trámites aduaneros, etc.) serán las resultantes de las condiciones particulares pactadas (INCOTERMS EN VIGOR). Las condiciones generales aquí detalladas, salvo posibles modificaciones o excepciones acordadas por escrito, regulan todos los contratos de venta celebrados entre nuestra empresa y el comprador, y por consiguiente, tanto el contrato concluido al aceptar el presente pedido, como cualquier futuro contrato de suministro de los productos de nuestra empresa que se solicitarán con sucesivos y distintos pedidos. Las variaciones de las condiciones generales de venta, las ofertas, las transacciones, los abonos o los descuentos, acordados por nuestros Agentes u otros intermediarios, no se consideran válidos si nuestra sede no los ha aceptado por escrito, limitándose, en cualquier caso, a los contratos a los que se refieren.

2. SUMINISTRO Y ENTREGA

Tras la recepción de la mercancía, el comprador está obligado a examinarla inmediatamente en cuanto a sus defectos o vicios. Los defectos externos o visibles deberán notificarse por escrito a LVG Ceramic Surfaces. S.L. en el plazo de quince (15) días desde la recepción de la mercancía. Tratándose de vicios ocultos el plazo de reclamación será de treinta (30) días desde su recepción. Si el comprador no realiza notificación alguna de defectos en dichos plazos, la mercancía se considerará conforme. La parte compradora de una mercancía que se encuentre en estado defectuoso, como se ha indicado, debe reclamar en plazo y optar a las siguientes vías de solución:

1. La entrega de una mercancía nueva a cambio de la devolución de la defectuosa.

2. Reintegro del precio abonado a cambio de la devolución de la defectuosa.

Por otra parte, el distribuidor se responsabiliza de adjuntar en la factura que debe dar al cliente tanto la Garantía, como las especificaciones técnicas y mantenimiento.

3. DEVOLUCIÓN

La mercancía defectuosa debe devolverse en el estado y con en el embalaje mediante el cual ha sido entregada. Los pedidos recibidos directamente de los clientes o realizados por nuestros representantes en nombre de ellos siempre estarán sujetos a nuestra aceptación. Se tiene en cuenta que la realización de una devolución aceptada por LVG Ceramic Surfaces. S.L. no significa que se asuma o reconozca la reclamación debida a defectos en la mercancía. En caso de defectos en la cantidad suministrada, el comprador tendrá únicamente derecho a poder reclamar la cantidad no entregada.

4. ENTREGA

Las mercancías entregadas por LVG Ceramic Surfaces. S.L. están sujetas a reserva de dominio. La propiedad de la mercancía únicamente pasará al comprador en el momento en que esté completamente pagada. LVG Ceramic Surfaces. S.L. tiene derecho a compensar cualquier suma que le adeude el comprador contra cualquier suma que resulte pagadera al comprador. En caso de incumplimiento de las condiciones de pago y/o devolución de los efectos negociados, serán de cuenta del comprador los gastos de devolución más los gastos de administración y reclamación judicial que se originen en su caso, incluidos los honorarios de letrados y procuradores. En caso de mora en el pago de la mercancía por el comprador, así como si sufriera embargo en sus bienes o si se produjera un empeoramiento sustancial de su situación patrimonial, LVG Ceramic Surfaces. S.L. estará facultada para reclamar el pago inmediato del importe facturado y retener todos los suministros y prestaciones pendientes y condicionar la entrega de las mercaderías - aun cuando el comprador ya no se encuentre en mora - al pago por adelantado de las mismas así como, en su caso, a reclamar la indemnización correspondiente. En ningún caso la mercancía podrá ser objeto de reventa mediante el uso de una página web (venta online). Siempre que no existan acuerdos contrarios, se prohíbe al Comprador exportar los materiales que le suministre nuestra empresa, o cedérsela a empresas o personas que los exporten.

5. TRIBUNAL COMPETENTE

Las partes someten las relaciones resultantes entre las mismas a lo dispuesto en la Legislación del Reino de España y, con renuncia expresa al propio fuero que pudiera corresponderles, se someten a los juzgados y tribunales de Vila-real (Castellón) para resolver cualquier controversia, conflicto o reclamación que surja en conexión con la relación comercial establecida entre las mismas.

6. PROTECCIÓN DE DATOS DE CARÁCTER PERSONAL

Conforme a la Ley Orgánica del 3/2018 de 5 de diciembre de Protección de Datos de Carácter Personal, los datos de carácter personal facilitados por el comprador formarán parte del fichero de clientes de LVG Ceramic Surfaces. S.L., cuyos fines son el mantenimiento de la relación contractual, el control y gestión de las ventas y sus correspondientes cobros. LVG Ceramic Surfaces. S.L. tratará dichos datos con la máxima confidencialidad, y se compromete a no utilizarlos con un fin distinto a aquel para el que han sido recabados, así como a conservarlos con las debidas medidas que garanticen su seguridad y eviten su alteración, pérdida, tratamiento o acceso no autorizados. El comprador tiene la posibilidad de ejercitar los derechos de acceso, rectificación, cancelación y oposición dirigiendo una comunicación por escrito a LVG Ceramic Surfaces. S.L..

2025 Edition
V. I

The taps, siphons and decorative elements present in the catalog images are not included and make up a proposal in the presentation of our products.

Los grifos, sifones y elementos decorativos presentes en las imágenes del catálogo no están incluidos y conforman una propuesta en la presentación de nuestros productos.

Legal Information | Información Legal

LVG Ceramic Surfaces, S.L. reserves the right to make changes and modifications deemed necessary due to process modifications or errors in the catalogue. Because of the printing process, the colors shown in this catalog are approximate, not exact. The information in this catalog is fully protected by copyright. Total or partial reproduction of text, illustrations, images and graphical representations is forbidden without the express permission of living ceramics.

LVG Ceramic Surfaces, S.L. se reserva el derecho de hacer variaciones y modificaciones que considere oportunas por modificaciones de procesos o errores en el catálogo. A causa de los procesos de impresión, los colores que aparecen en este catálogo deben considerarse aproximados, no exactos. La información de este catálogo está protegida en su totalidad por copyright. Está prohibida la reproducción total o parcial de los textos, ilustraciones, imágenes y representaciones gráficas sin la autorización expresa de living ceramics.



Headquarters And Warehouse
Oficinas Y Logística

Ctra. Vila-real – Onda CV 20 KM 2.5
12540, Vila-real, Castellón, Spain

Production Center
Centro De Producción

Ctra. Onda – Ribesalbes CV 191 KM 3
12200, Onda, Castellón, Spain

Showroom Vila-real

Showroom Barcelona

Ctra. Vila-real – Onda CV 20 KM 2.5
12540, Vila-real, Castellón, Spain

Avenida Diagonal 499
08029, Les Corts, Barcelona, Spain

Tel. +34 964 914 181

Tel. +34 936 118 308

Livingceramics

www.livingceramics.com

info@livingceramics.com
Tel. +34 964 914 181

With every design, we honor the timeless connection between *creativity*, *nature* and the *spaces* we call home.

Thank you for being part of our journey.

Con cada diseño, honramos la conexión intemporal entre la creatividad, la naturaleza y los espacios que llamamos hogar.

Gracias por ser parte de nuestro viaje.

A tale of
design shaped together

