

BATHROOM
FURNITURE
SERIES

Livingceramics

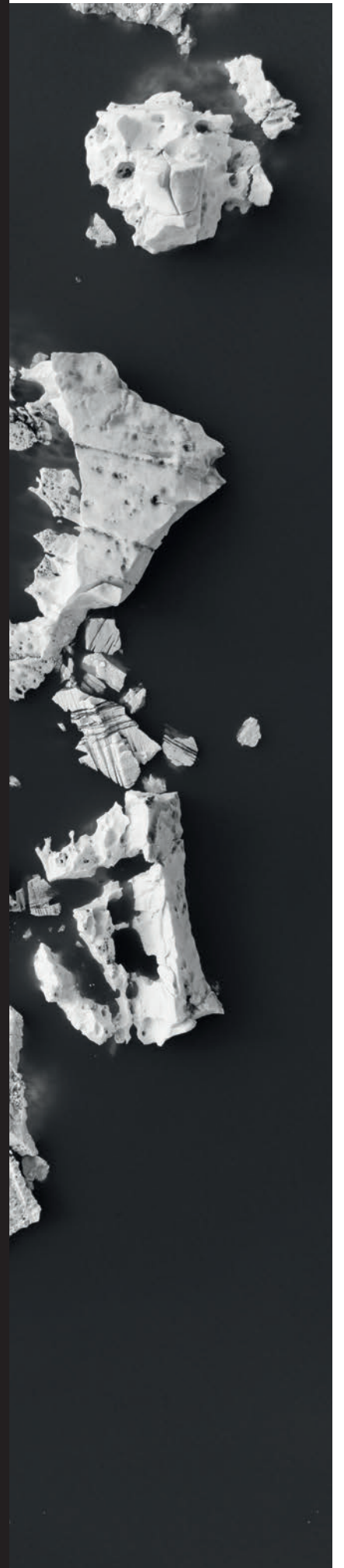

SURFACES TEXTURES ARCHITECTURE

IT'S ALL ABOUT THE JOURNEY

39°56'53.0"N 0°09'



**JOIN US
IN OUR
EXPERIENCE**

While working on the process of creating ceramic surfaces capable of surprising you both technically and aesthetically, we have realized one thing: it has been a truly exciting journey capable of making a difference. Come and join us.

Mientras trabajábamos en el proceso de creación de superficies cerámicas capaces de sorprenderte tanto a nivel técnico como estético, nos hemos dado cuenta de una cosa: ha sido un viaje realmente apasionante capaz de marcar la diferencia. Acompáñanos.

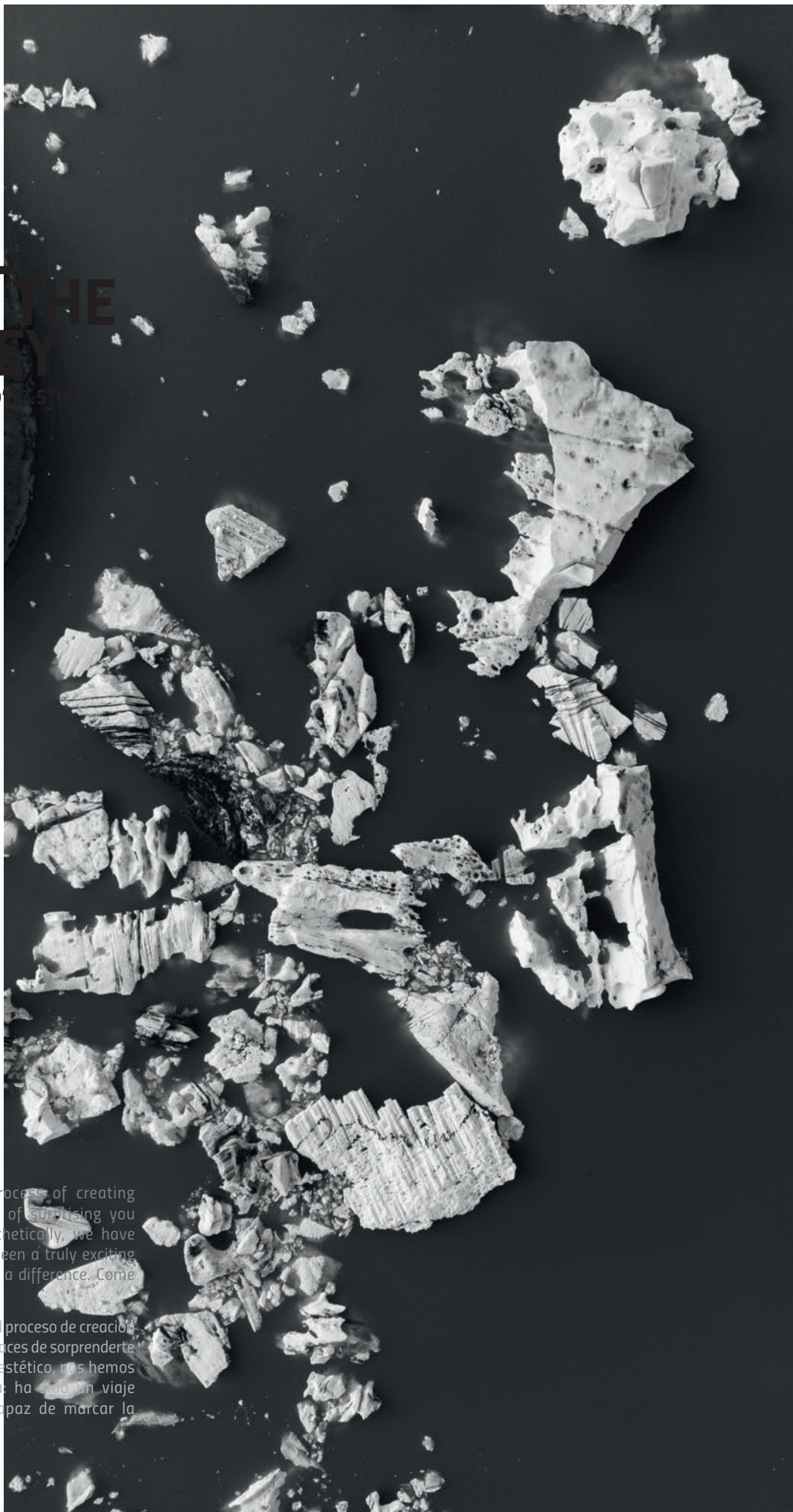

The New Bathroom Furniture El Nuevo Mueble de Baño

Livingceramics aspires to help create unique exclusive settings, developing products conceived to meet consumer needs and to fit in with the latest trends. With this in mind, we have created an extensive range of washbasin units with a strong design appeal, bringing the very essence of Livingceramics to a selection of exclusive models. The idea behind these new collections is to use our ceramic tiles to create items of bathroom furniture, hence lending added value to our series. These products can be used to transform bathrooms into stylishly elegant settings, with a wide choice of formats and finishes to boost the capacity for customization. The manufacturing process integrates careful craftsmanship with cutting-edge technology, with designs that reflect the passion and care we pour into every single detail.

El deseo de Livingceramics es llegar a ofrecer espacios únicos y exclusivos, desarrollando proyectos que se adapten a las necesidades del cliente y que reflejen las nuevas tendencias. Para ello, apostamos por crear una amplia gama de baño con elementos de diseño, llevando la esencia de Livingceramics a diferentes y exclusivas composiciones. Estas nuevas colecciones surgen de la idea de transformar nuestra cerámica en piezas de mobiliario, dándole un valor añadido a nuestras series. El resultado son ambientes donde se destaca la elegancia junto a una amplia gama de formatos, ofreciendo una mayor personalización en el diseño al poder decidir entre los diferentes acabados. En el desarrollo de cada pieza se combina la artesanía con las últimas tecnologías, creando composiciones donde se refleja el cuidado y la pasión que se han utilizado en el diseño de cada detalle.

Livingceramics



Livingceramics Showroom



SHOWROOM

We are non-conformists with a passion for detail and determined to achieve optimum results in everything we do. We believe that the best way of demonstrating our work is to share what we feel with you, which is why our head offices include a space that reflects the true character of our brand. These pages will take you on a tour of our Showroom; our home is ready to welcome you, so enjoy the visit and find out how ceramic tile architecture became our true passion and vocation. Welcome to Livingceramics.

Somos inconformistas, nos gustan los detalles e insistimos con el fin de obtener un resultado óptimo en todo lo que hacemos. Pensamos que la mejor manera de demostrar nuestro trabajo es que lo sientas como nosotros, por eso, en nuestras oficinas centrales, tenemos una muestra del carácter que respira la marca. En estas páginas, te invitamos a entrar en nuestro Showroom, nuestra casa se abre para recibirte, así que disfruta del paseo y descubre cómo la arquitectura cerámica se ha convertido en nuestra pasión. Bienvenido a Livingceramics.

Sustainable Tiles Cerámica Sostenible

From Livingceramics we work under the criteria of respect for the environment, safety and health at work. This philosophy has led us to be part of the Green Building Council, a non-profit association formed by companies that work to make our environments sustainable and responsible. We ensure safety in the workplace by training our personnel in safety and environmental aspects. Concepts such as energy sustainability are important for the company, and this is demonstrated by the external audits that guarantee our quality seals. All our containers and packaging are recyclable. Even the catalog that you have in your hands, has been designed using FSC papers that support a controlled repopulation of one of our greatest legacies, the forests.

Desde Livingceramics trabajamos bajo los criterios de respeto al medio ambiente, la seguridad y la salud en el trabajo. Esta filosofía nos ha llevado a formar parte del Green Building Council, una asociación sin ánimo de lucro formada por empresas que trabajamos para que nuestros entornos sean sostenibles y responsables. Velamos por la seguridad en el ámbito laboral formando a nuestro personal en aspectos de seguridad y medio ambiente. Conceptos como la sostenibilidad energética son importantes para la empresa, y ello se demuestra con las auditorías externas que avalan nuestros sellos de calidad. Todos nuestros envases y embalajes son reciclables. Incluso el catálogo que tienes entre las manos, se ha diseñado utilizando papeles FSC que avalan una repoblación controlada de uno de nuestros mayores legados, los bosques.

GREEN BUILDING MEMBER / MIEMBRO DEL GREEN BUILDING COUNCIL
CERTIFIED COMPANY ISO 9001 / EMPRESA CERTIFICADA ISO 9001
USE OF CERTIFICATE FSC PAPER / USO DE PAPEL CON CERTIFICADO FSC



Heritage Craftmanship Artesanía Heredada

Our new bathroom collection is elegant and contemporary in design, with units featuring tiles by Livingceramics. In the development of each unit, careful craftsmanship is combined with cutting-edge machining techniques. The final outcome is a range of washbasins and basin units with a handcrafted finish, based on an innovative manufacturing process. The collection comes in a wide choice of formats to suit differing settings, perfect for creating one-of-a-kind customized bathrooms. Our long experience in the tile sector and expertise in developing products with a distinctive flair have both been channelled into our bathroom collection, with models that embody the very essence of Livingceramics. Our aim is not just to develop differing tile collections, but to contribute to the creation of unique settings.

La nueva colección de baños sigue una línea contemporánea y elegante, presentando piezas que están relacionadas con los acabados cerámicos de la marca. En el desarrollo de cada mueble existe una estrecha relación entre la artesanía y los centros de mecanizado más actuales. Como resultado, se define una gama de lavabos y muebles con un acabado manual, sin dejar atrás un innovador proceso de fabricación. Se presenta una amplia variedad de formatos, adaptándose a diferentes espacios y creando ambientes únicos y personalizados. Nuestra experiencia en el sector cerámico y el buen gusto de la empresa por crear elementos distintivos, se transfiere a estas nuevas colecciones de baño creando piezas que plasman la esencia de Living. No solo pensamos en ofrecer diferentes colecciones de cerámica, sino que queremos crear espacios únicos para todos nuestros clientes.



Cross Dry Oak Finish Detail combined with Kendo Light Soft Textured

A Bath For Each Person Un Baño Para Cada Persona

Customization is all important, and so our units come in different sizes, with models suitable for different tap mountings. Each collection is rounded off with an exclusive bathroom unit made of solid oak. For this purpose, five designs in different finishes have been developed, all illustrating the company's passion for up-to-the-minute trend-setting ideas. The units are available in four oak textures, both reflecting the very essence of the collection, in designs conspicuous for their purity, balance and stylish elegance.

Livingceramics has embarked on a new initiative, helping clients to customize settings in exclusive style. Through the development of designer products conceived to help create one-of-a-kind bathrooms, tiles by the company can be combined with matching washbasin units.

La personalización es un factor fundamental, por ello se ofrecen muebles en diferentes tamaños, teniendo la posibilidad de escoger un diseño adaptado para grifería. Cada colección se complementa con una pieza de mobiliario exclusiva fabricada en roble macizo. Por ello, se han trazado cinco propuestas de diseño con diferentes acabados que reflejan el gusto por la marca por ofrecer una pieza actual y de tendencia. Estas composiciones están disponibles en cuatro texturas de roble que reflejan la esencia de la colección, un diseño equilibrado, puro y elegante.

Livingceramics inicia un nuevo proyecto ofreciendo una personalización exclusiva en los ambientes y creando piezas de diseño en espacios únicos, ofreciendo la posibilidad de combinar un revestimiento de la marca con sus muebles de baño a juego.

Combinations

Combinaciones

Without furniture
Sin mueble

Unit
Furniture with two interior drawers
Mueble con dos cajones interiores

Cabinet
Cabinet with drawers
Mueble con cajones

Frame
Wood cover
Forro de madera

Drawer
Chest of drawers located under the basin
Cajonera situada bajo el lavabo

Line
Chest of drawers
Cajonera



A.71

A.71 [240]
A.71 [180]
A.71 [120]

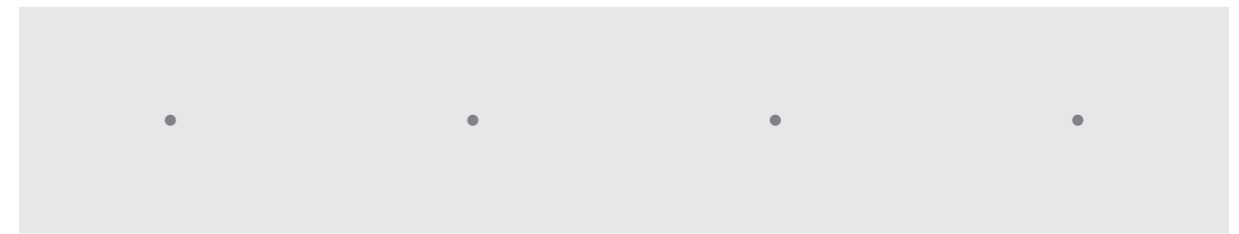
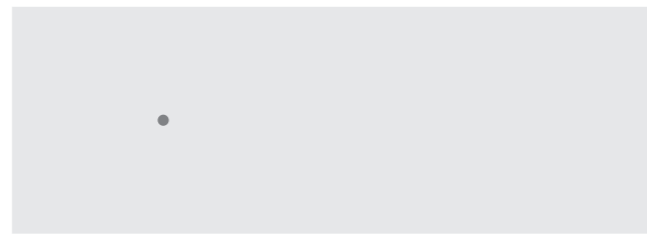

L.28

L.28 [240]
L.28 [180]
L.28 [120]
L.28 [90]



W.37

W.37 [240]
W.37 [180]
W.37 [120]
W.37 [90]

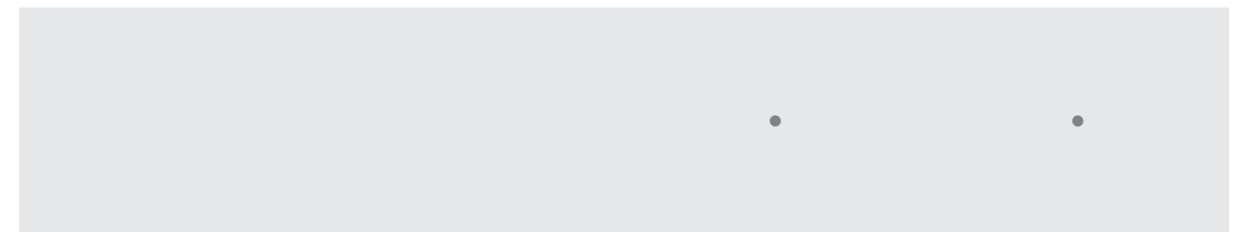
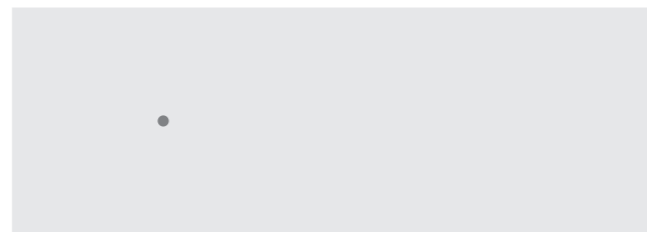

G.19

G.19 [240]
G.19 [180]
G.19 [120]
G.19 [90]
G.19 [47] & [47UN]
G.19 [47x90]



Ceramic Finishes

Acabados Cerámicos

Allure

Marbled Stone in Ceramics
Piedra Veteada Cerámica



Sand Light Grey Grey Anthracite

Bera&Beren

Lusitan & Catalan Limestone Ceramics
Caliza Lusitana & Catalana Cerámica



Ice White Sand Light Grey Biscuit Greige Dark Grey Black

Blanc

White Marble Stone in Ceramics
Mármol Blanco en Cerámica



Calacatta Calacatta Gold Statuario Gold Invisible

Cuit

Mud Art in Ceramics
Arte en Barro Cerámico



Bone Grey Clay Terra Charcoal

Eme

Mediterranean Stone in Ceramics
Piedra mediterránea Cerámica



Light Grey Grey Anthracite

Floss

Natural Cement Ceramics
Cemento Natural Cerámico



Bone Silver Smoky Graphite

Gubi

Microcement Ceramics
Microcemento Cerámico

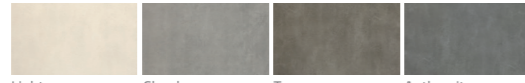

Light Cloud Taupe Anthracite

Kendo

Jura Stone in Ceramics
Piedra Jura en Cerámica



Kendo Ice Kendo Light Kendo Classic

Kovo

Mixed Concrete in Ceramics
Mezcla de Cementos en Cerámica

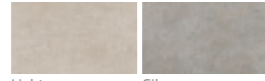

Light Silver

Noon

Northern Stone in Ceramics
Piedra del Norte Cerámica



Sand Grey Anthracite

Verso Vein Cut

Travertine Stone in Ceramics
Piedra Travertino en Cerámica



Light Classic Grey

Verso Cross Cut

Travertine Stone in Ceramics
Piedra Travertino en Cerámica

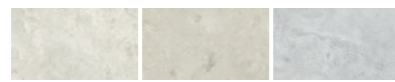

Light Classic Grey

Vonn

Textured Stone in Ceramics
Piedra Texturada en Cerámica

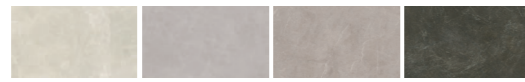

Light Grey Greige Anthracite

Kron Tech

Concrete in Tech. Porcelain
Cemento en Porcelánico Téc.



Grey

Wega Tech

Volcanic Stone in Tech. Porcelain
Piedra Volcánica en Porcelánico Téc.



Black



Verso
Travertine Stone in Ceramics
Piedra Travertino en Cerámica

UIG Ceramics Surfaces, S.L.
C/da Vía del Mar, 1 - 04010 San Blas (Cádiz)
41010 San Blas (Cádiz) - Spain (2120 Km. 2.5)
Apto. Correo 30 - 11110 San Blas (Cádiz) - Spain (109)
Cif: B123022000 - T: +34 964 914 181 - F: +34 964 914 250
www.uigceramics.com - info@uigceramics.com

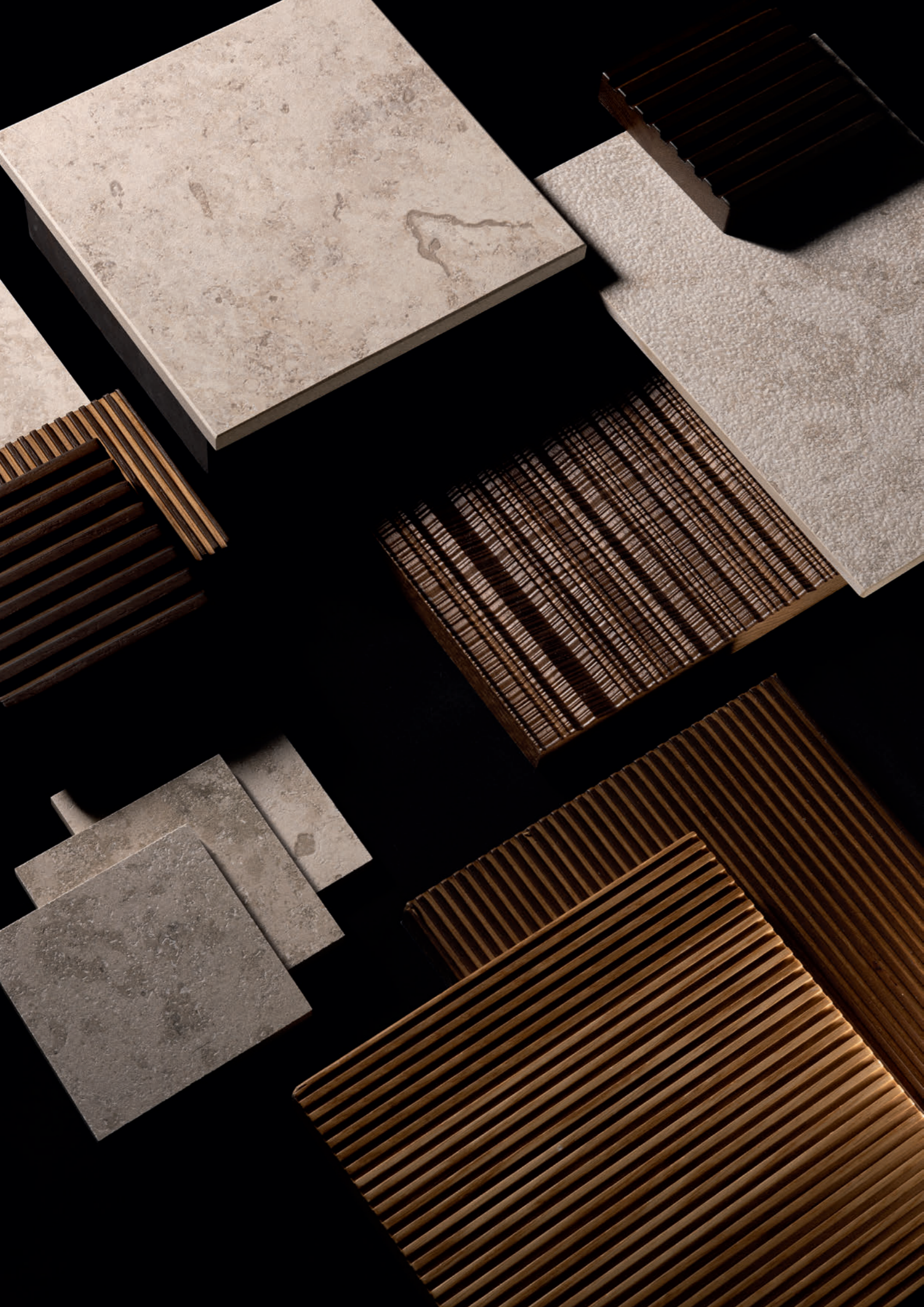

Wooden finishes

15

Natural Oak

Solid natural oak wood
Madera maciza de roble natural

Dark Oak

Solid natural dark brown oak wood
Madera maciza de roble marrón oscuro

Dry Oak

Solid natural grey oak wood
Madera maciza de roble gris

Ribbed

Horizontal large grooves
Ranuras grandes horizontales



Shadow

Vertical slight grooves
Ranuras pequeñas verticales

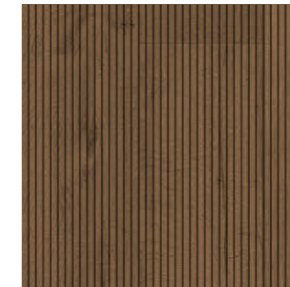

Striped

Horizontal sawned grooves
Ranuras aserradas horizontales

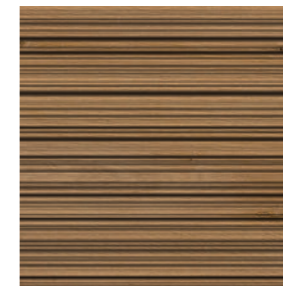

Cross

Crossed grooves
Ranuras cruzadas



THE ART OF MIXING EL ARTE DE COMBINAR

At Livingceramics, meticulous attention is paid to each design and to all the finer details through an artful use of balance, form and composition. We aspire to contribute to the creation of bathrooms with personality, offering clients the freedom to choose the materials they prefer combined with other features, offering thousands of carefully designed solutions. Every single detail is important to us, leading to the development of products whose carefully chosen lengths and finishes contribute to their balanced design. Their colours, textures and volumes all complement one another to harmonious effect. Each model's finely traced lines, based on studies of inspirational designs and architecture, epitomize the very spirit of Livingceramics.

En Livingceramics cuidamos cada detalle, cada diseño, plasmando el arte en sus formas y el equilibrio en su composición. Buscamos que cada baño tenga su personalidad, dando la libertad en la selección del material y en la relación entre sus elementos; creando miles de soluciones, las cuales han sido estudiadas en todas sus definiciones. Cada encuentro, cada trazo, es importante para nosotros, definiendo el equilibrio en sus dimensiones y acabados. Los colores, las texturas, las perspectivas... se complementan creando una perfecta armonía en sus formas. La esencia de Livingceramics se define en las líneas finas de cada modelo, basándose en el estudio de los diseños y obras arquitectónicas más inspiradoras.



G.19 [47x90] Kendo Light Soft Textured Basin

G.19 [39] Kendo Light Soft Textured Basin & Cabinet [47 Island] Cross Dry Oak



G.19 [47x90] Kendo Light Soft Textured Basin

G.19 [39] Kendo Light Soft Textured Basin & Cabinet [47 Island] Cross Dry Oak



G.19 [47x90] Kendo Light Soft Textured Basin

G.19 [39] Kendo Light Soft Textured Basin & Cabinet [47 Island] Cross Dry Oak



G.19 [47 UN] Kron Grey Soft Textured Basin
Unit Shadow Dark Oak



G.19 [47 UN] Kron Grey Soft Textured Basin
Unit Shadow Dark Oak



G.19 [47x90] Noon Grey Soft Textured Basin

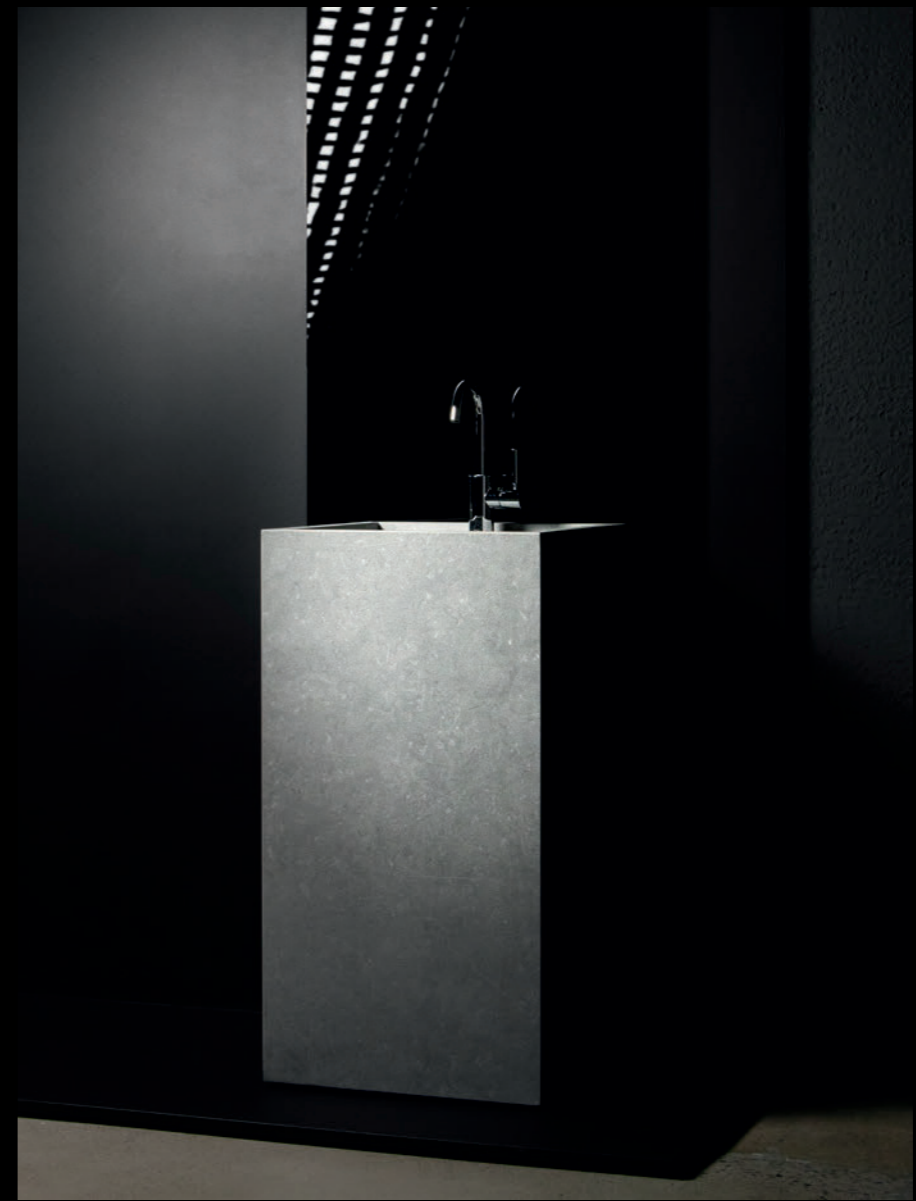

G.19 [47x90] Noon Grey Soft Textured Basin



A.71 [240] Eme Grey Soft Textured Basin



L.28 Collection Noon Sand Soft Textured Basin
Frame Shadow Natural Oak



A.71 [240] Blanc Calacatta Gold Soft Textured Basin
Drawer [240] Striped Natural Oak



Line [240] Striped Natural Oak

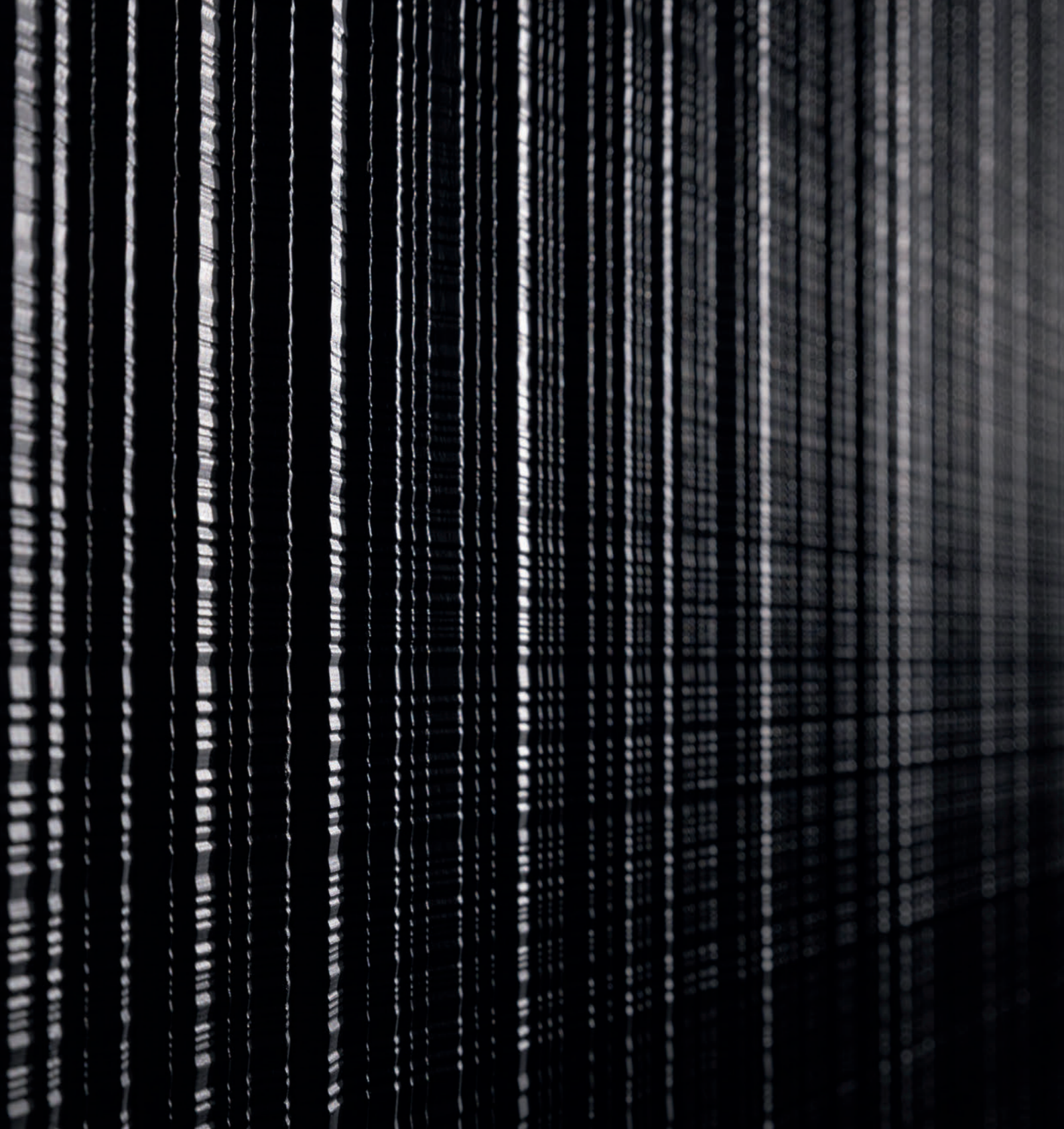

Cross Dry Oak Finish Detail

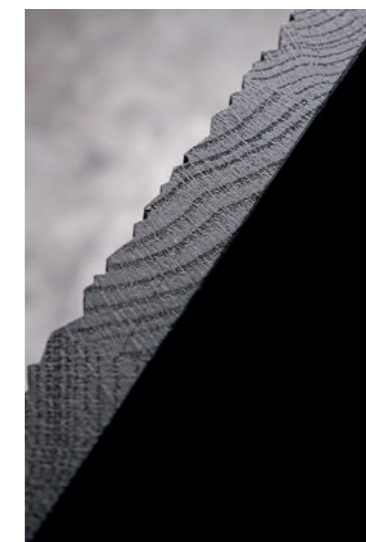

BATHROOM FURNITURE SERIES

Livingceramics seeks to contribute to the creation of 100% contemporary spaces. That is why we present our collection of washbasins and bathroom furniture. Elegant volumes, meticulous craftsmanship and high quality raw materials are at your service to create bathrooms that breathe design. An effective and inspiring work tool at the same time.

Livingceramics busca contribuir a la creación de espacios 100% contemporáneos. Por eso presentamos nuestra colección de lavabos y muebles de baño. Volúmenes elegantes, artesanía meticulosa y materias primas de alta calidad se ponen a su servicio para crear baños que respiran diseño. Una herramienta de trabajo eficaz e inspiradora.

Livingceramics



A.71

A.71 [232] Eme Grey Soft Textured Basin
Cabinet [240] Shadow Natural Oak
90x240x47cm
36"x95"x19"



A.71 [232] Eme Grey Soft Textured Basin
Cabinet [240] Ribbed Natural Oak
90x240x47cm
36"x95"x19"

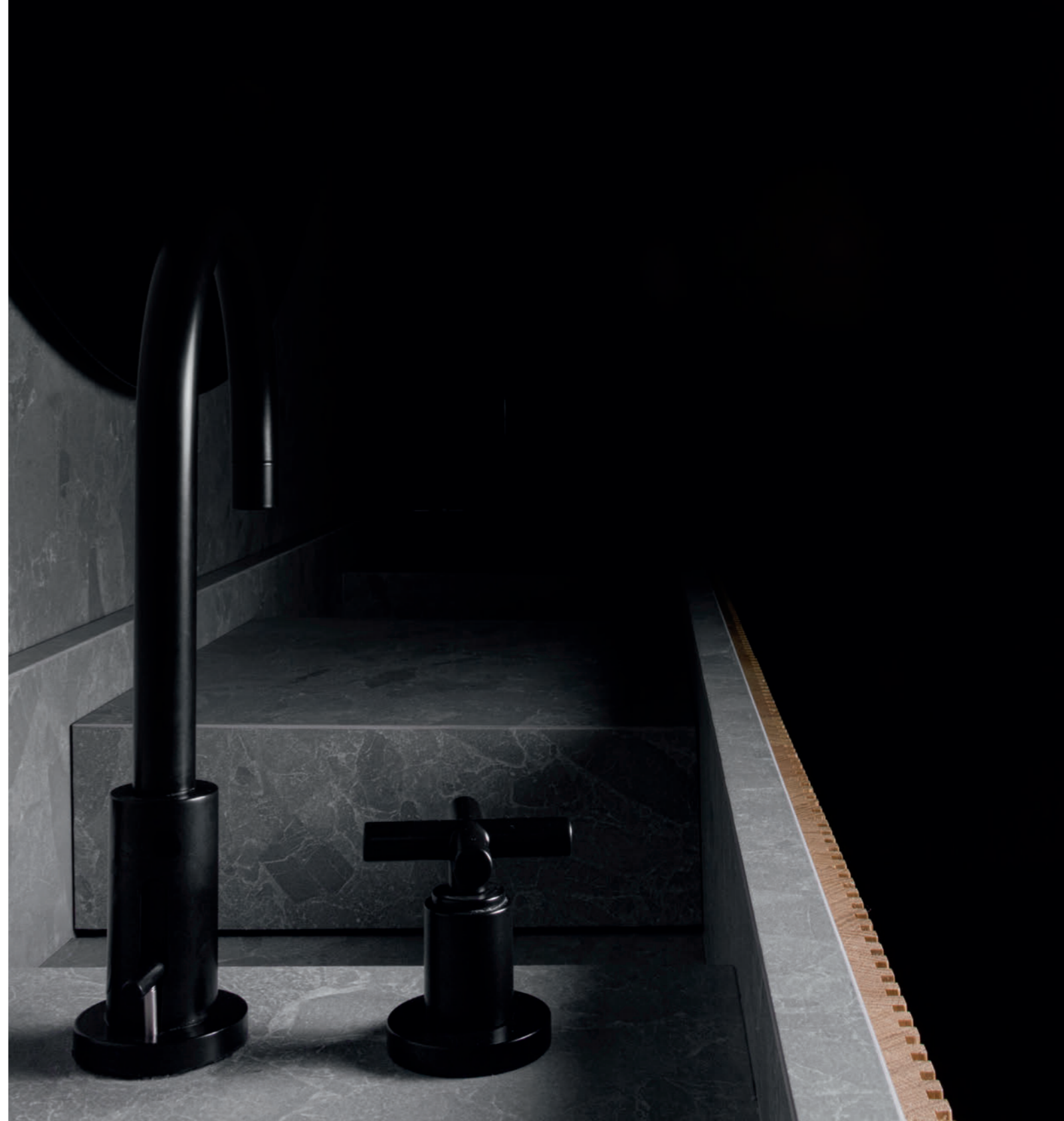

A.71 [236] Eme Grey Soft Textured Basin
Frame [240] Shadow Natural Oak
27x240x47cm
11"x95"x19"



L.28

L.28 [236] Noon Sand Soft Textured Basin
Frame [240] Shadow Dark Oak
27x240x47cm
11"x95"x19"

Line [240] Shadow Dark Oak
24x240x47cm
10"x95"x19"



L.28 [236] Noon Sand Soft Textured Basin
Frame [120] Shadow Dark Oak
27x240x47cm
11"x95"x19"



L.28 [116] Noon Sand Soft Textured Basin
Frame [120] Ribbed Dark Oak
26x120x47cm
11"x48"x19"



W.37

W.37 [120] Beren Black Soft Textured Basin
20x120x52cm
8"x48"x21"

Drawer [120] Ribbed Natural Oak
36x120x47cm
14"x48"x19"

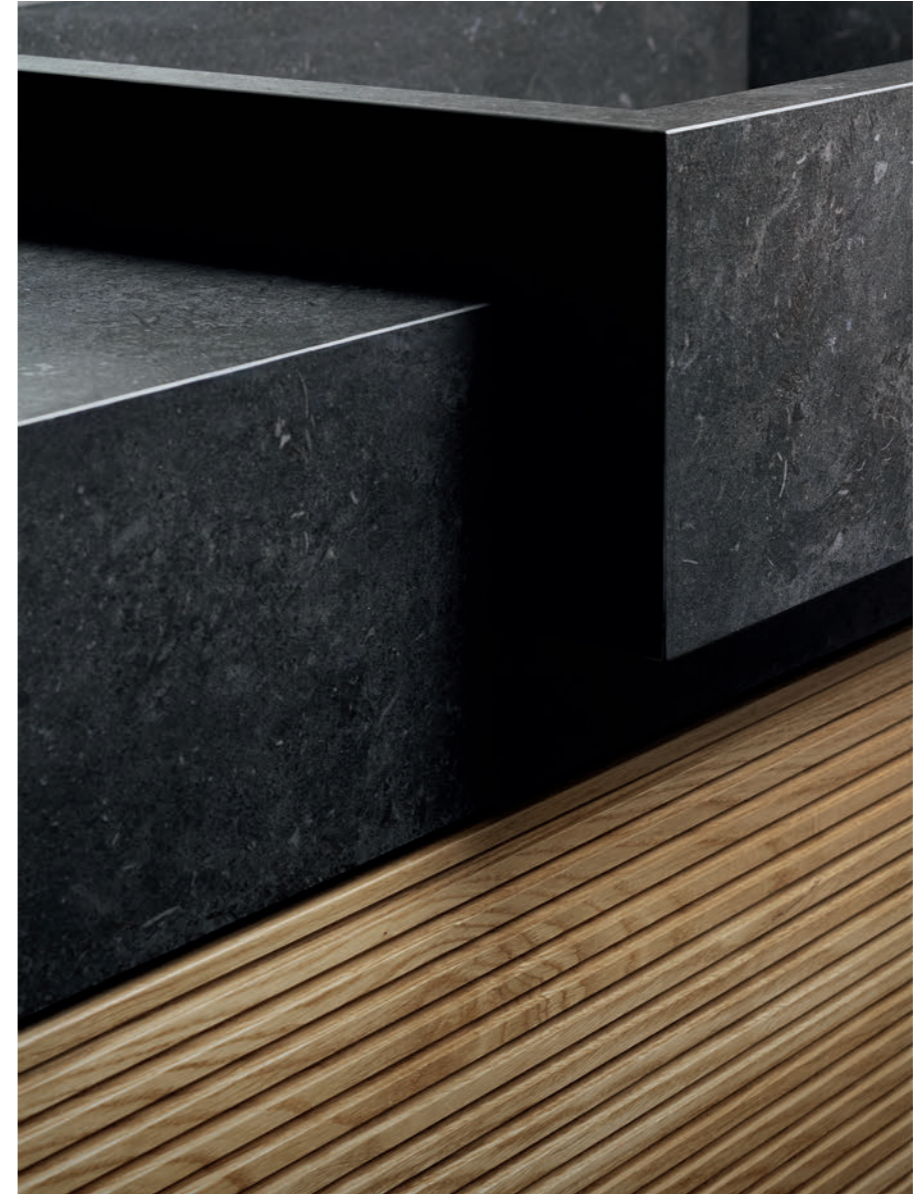
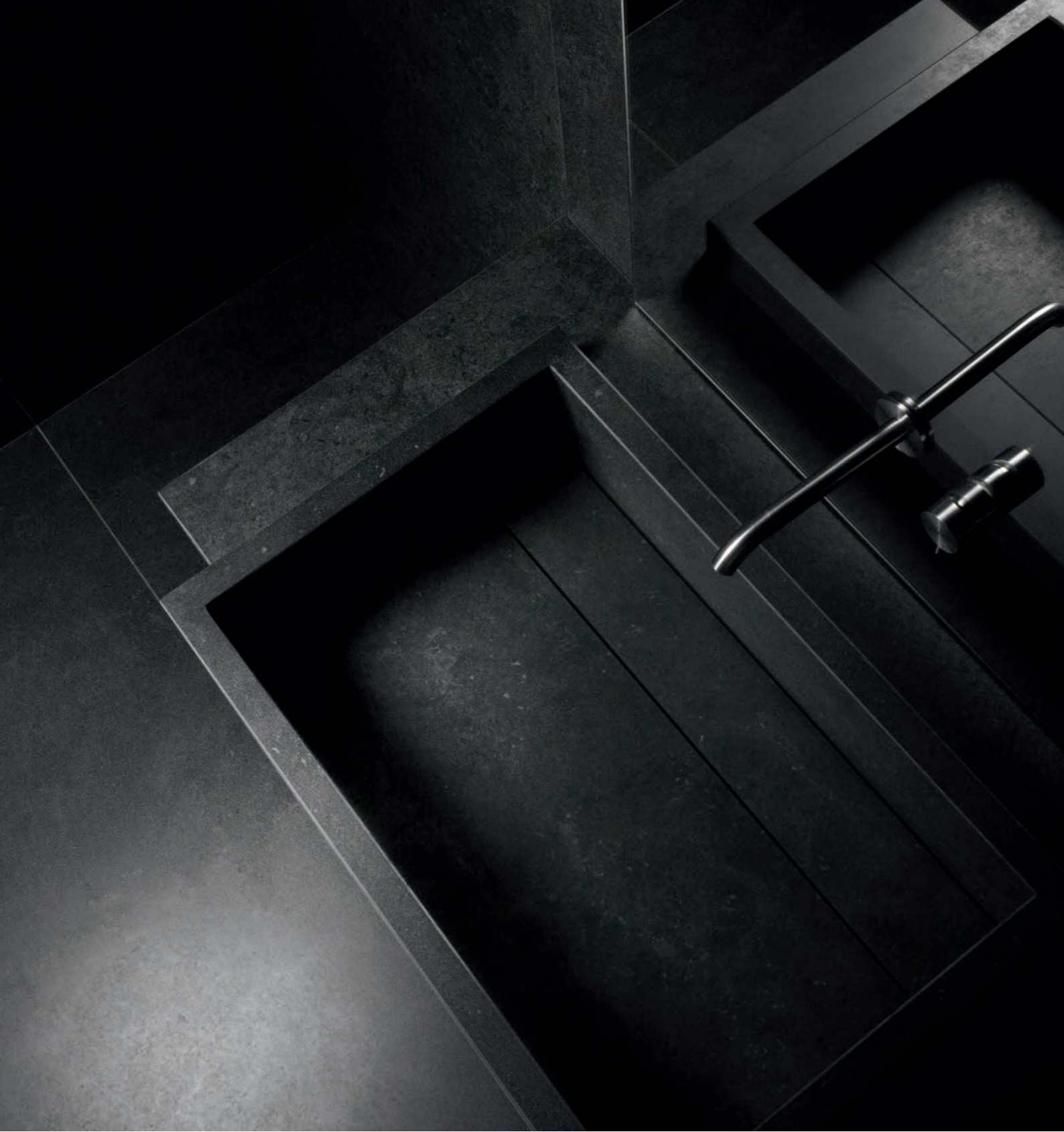

W.37 [90] Beren Black Soft Basin
20x90x52cm
8"x36"x21"

Drawer [90] Ribbed Natural Oak
36x90x47cm
14"x36"x19"



G.19

G.19 [232] Vonn Grey Soft Textured Basin
Cabinet [240] Cross Dark Oak
90x240x47cm.
35"x95"x19"



G.19 [232] Vonn Grey Soft Textured Basin
Cabinet [240] Cross Dark Oak
90x240x47 cm.
35"x95"x19"

Technical Information
Información Técnica

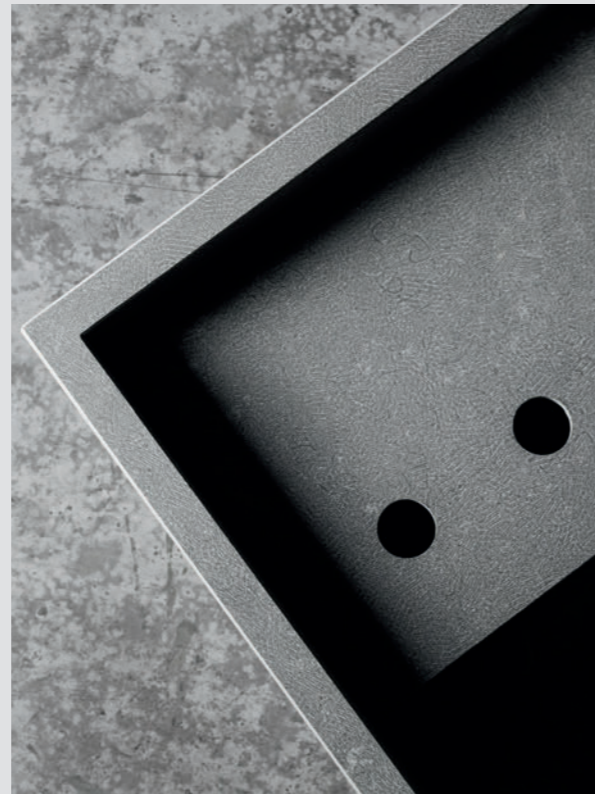

Basin Composition





A.71 [240] Noon Grey Soft Textured Basin
20x240x47cm
8"x95"x19"

A.71 Series

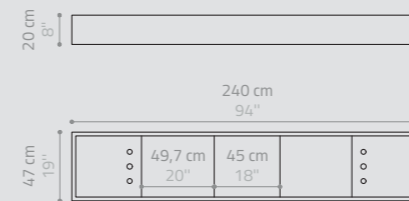
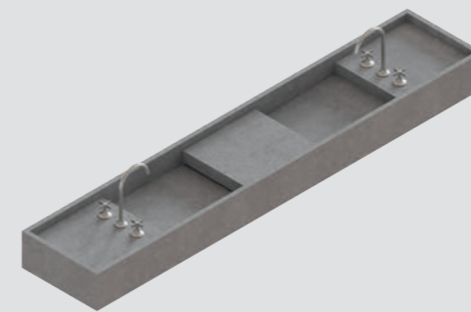

with tap
con grifo

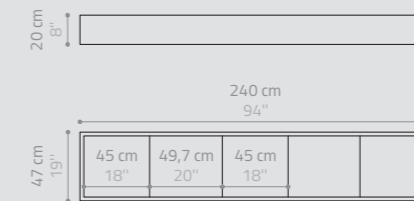
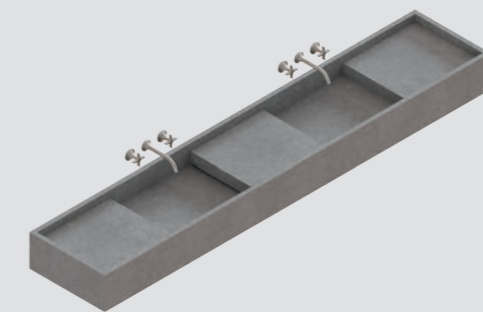

without tap
sin grifo

A.71 [240] with / without tap
A.71 [240] con / sin grifo

Combine with Furnitures
*Cabinet / *Frame / Drawer / Line
*Frame+Line
***Special Dimensions for:**
A.71 [232] & Cabinet
A.71 [236] & Frame
A.71 [236] & Frame+Line
Packaging values
height altura 40 cm / 16"
width anchura 275 cm / 109"
depth profundidad 59 cm / 24"



A.71 [180] with / without tap
A.71 [180] con / sin grifo

Combine with Furnitures
*Cabinet / *Frame / Drawer / Line
*Frame+Line
***Special Dimensions for:**
A.71 [172] & Cabinet
A.71 [176] & Frame
A.71 [176] & Frame+Line
Packaging values
height altura 40 cm / 16"
width anchura 215 cm / 85"
depth profundidad 59 cm / 24"

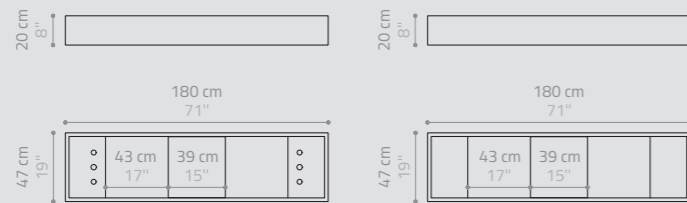

with tap
con grifo

without tap
sin grifo

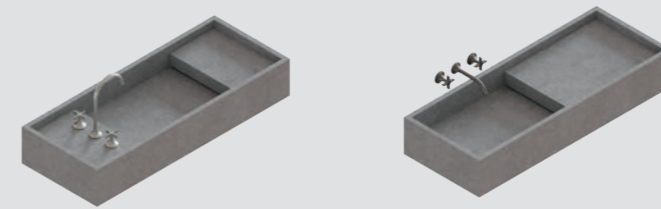

A.71 [120] with / without tap
A.71 [120] con / sin grifo

Combine with Furnitures
*Cabinet / *Frame / Drawer / Line
*Frame+Line
***Special Dimensions for:**
A.71 [112] & Cabinet
A.71 [116] & Frame
A.71 [116] & Frame+Line
Packaging values
height altura 32 cm / 13"
width anchura 155 cm / 61"
depth profundidad 59 cm / 24"

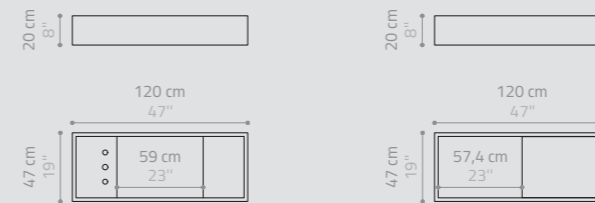

with tap
con grifo

without tap
sin grifo

L.28 Series

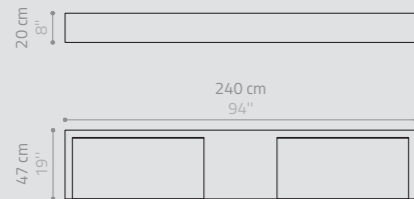
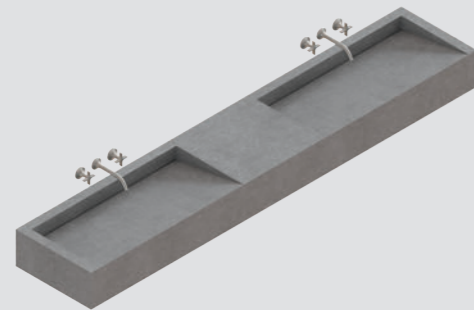

L.28 [240]

Combine with Furnitures

*Frame / Drawer / Line

*Frame+Line

*Special Dimensions for:

L.28 [236] & Frame

L.28 [236] & Frame+Line

Packaging values

height altura 40 cm / 16"

width anchura 275 cm / 109"

depth profundidad 59 cm / 24"

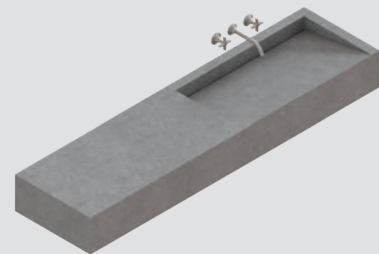

L.28 [180]

Combine with Furnitures

*Frame / Drawer / Line

*Frame+Line

*Special Dimensions for:

L.28 [176] & Frame

L.28 [176] & Frame+Line

Packaging values

height altura 40 cm / 16"

width anchura 215 cm / 85"

depth profundidad 59 cm / 24"

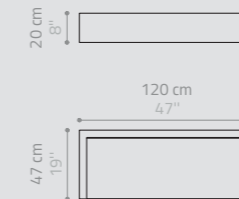
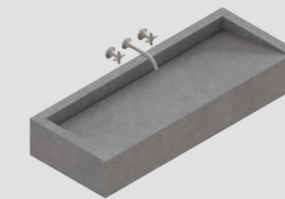

L.28 [120]

Combine with Furnitures

*Frame / Drawer / Line

*Frame+Line

*Special Dimensions for:

L.28 [116] & Frame

L.28 [116] & Frame+Line

Packaging values

height altura 32 cm / 13"

width anchura 155 cm / 61"

depth profundidad 59 cm / 24"

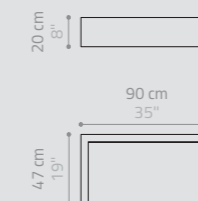

L.28 [90]

Combine with Furnitures

*Frame / Drawer / Line

*Frame+Line

*Special Dimensions for:

L.28 [86] & Frame

L.28 [86] & Frame+Line

Packaging values

height altura 32 cm / 13"

width anchura 125 cm / 50"

depth profundidad 59 cm / 24"

W.37 Series

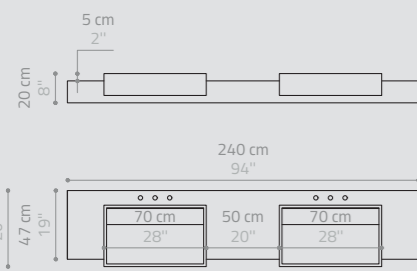
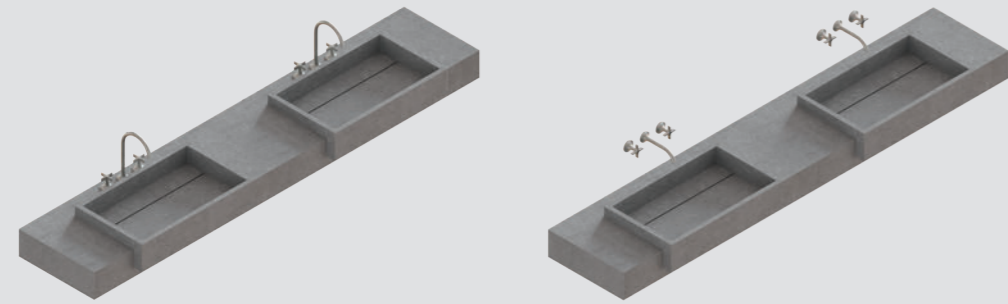

with tap
con grifo

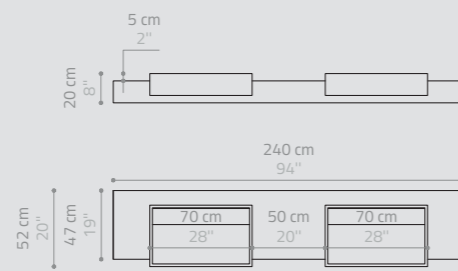

without tap
sin grifo

W.37 [240] with / without tap W.37 [240] con / sin grifo

Equipped with
Accessible drain under removable piece
Desagüe accesible bajo pieza móvil

Combine with Furnitures
Drawer / Line

Packaging values
height altura 40 cm / 16"
width anchura 275 cm / 109"
depth profundidad 64 cm / 26"

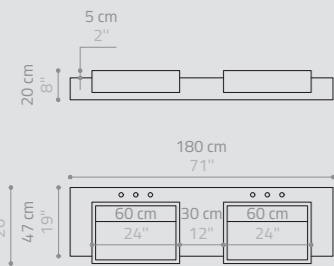
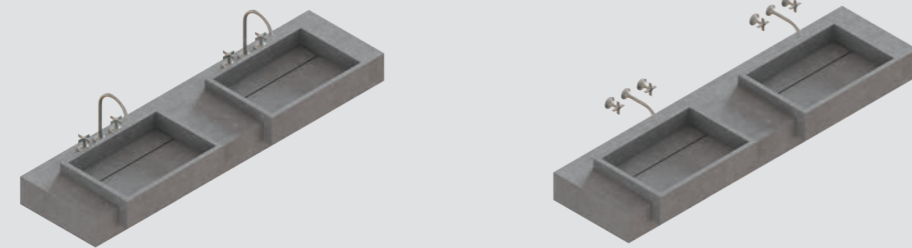

with tap
con grifo

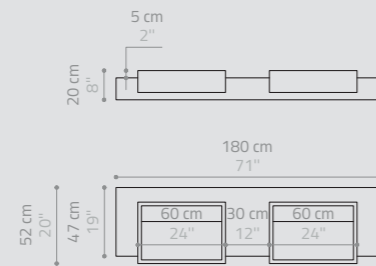

without tap
sin grifo

W.37 [180] with / without tap W.37 [180] con / sin grifo

Equipped with
Accessible drain under removable piece
Desagüe accesible bajo pieza móvil

Combine with Furnitures
Drawer / Line

Packaging values
height altura 40 cm / 16"
width anchura 215 cm / 85"
depth profundidad 64 cm / 26"

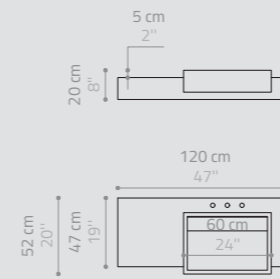

with tap
con grifo

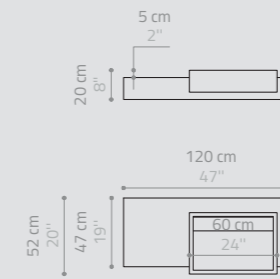

without tap
sin grifo

W.37 [120] with / without tap W.37 [120] con / sin grifo

Equipped with
Accessible drain under removable piece
Desagüe accesible bajo pieza móvil

Combine with Furnitures
Drawer / Line

Packaging values
height altura 32 cm / 16"
width anchura 155 cm / 61"
depth profundidad 64 cm / 26"

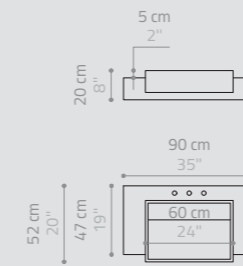
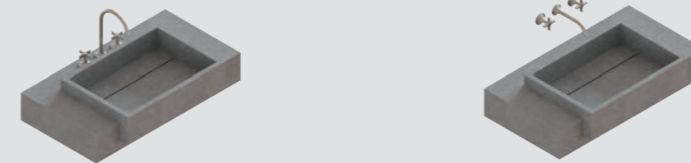

with tap
con grifo

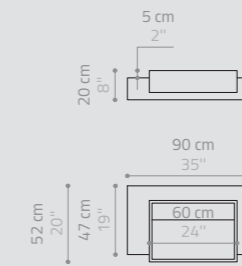

without tap
sin grifo

W.37 [90] with / without tap W.37 [90] con / sin grifo

Equipped with
Accessible drain under removable piece
Desagüe accesible bajo pieza móvil

Combine with Furnitures
Drawer / Line

Packaging values
height altura 32 cm / 16"
width anchura 125 cm / 50"
depth profundidad 64 cm / 26"

G.19 Series

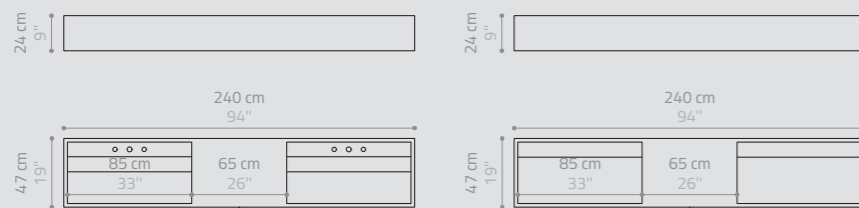
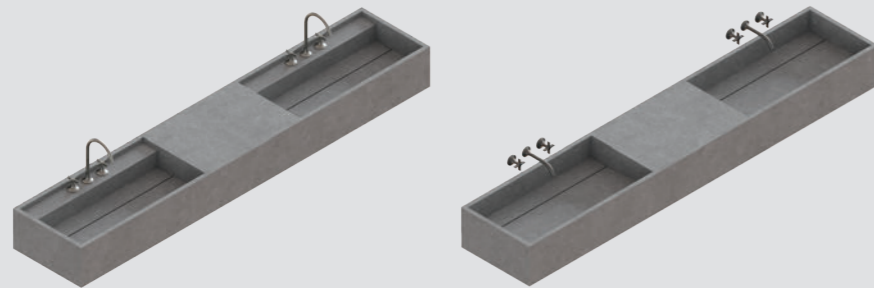

with tap
con grifo

without tap
sin grifo

G.19 [240] with / without tap
G.19 [240] con / sin grifo

Equipped with
Accessible drain under removable piece
Desagüe accesible bajo pieza móvil

Combine with Furnitures
*Cabinet / *Frame / Drawer / Line
*Frame+Line

***Special Dimensions for:**
G.19 [232] & Cabinet
G.19 [236] & Frame
G.19 [236] & Frame+Line

Packaging values
height altura 44 cm / 18"
width anchura 267 cm / 105"
depth profundidad 59 cm / 24"

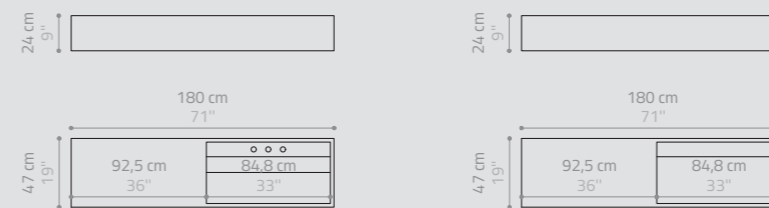
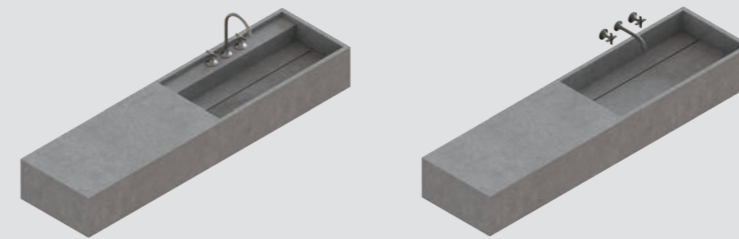

with tap
con grifo

without tap
sin grifo

G.19 [180] with / without tap
G.19 [180] con / sin grifo

Equipped with
Accessible drain under removable piece
Desagüe accesible bajo pieza móvil

Combine with Furnitures
*Cabinet / *Frame / Drawer / Line
*Frame+Line

***Special Dimensions for:**
G.19 [172] & Cabinet
G.19 [176] & Frame
G.19 [176] & Frame+Line

Packaging values
height altura 44 cm / 19"
width anchura 215 cm / 85"
depth profundidad 59 cm / 24"

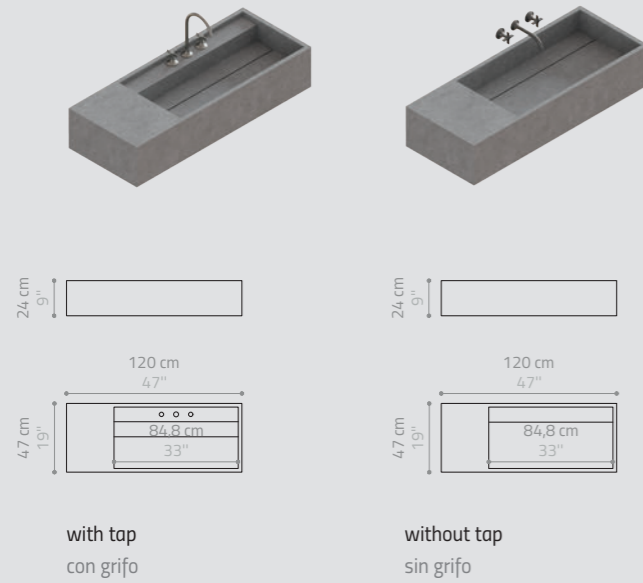

G.19 [120] with / without tap
G.19 [120] con / sin grifo

Equipped with
Accessible drain under removable piece
Desagüe accesible bajo pieza móvil

Combine with Furnitures
*Cabinet / *Frame / Drawer / Line
*Frame+Line

***Special Dimensions for:**
G.19 [112] & Cabinet
G.19 [116] & Frame
G.19 [116] & Frame+Line

Packaging values
height altura 36 cm / 15"
width anchura 155 cm / 61"
depth profundidad 59 cm / 24"

with tap
con grifo

without tap
sin grifo

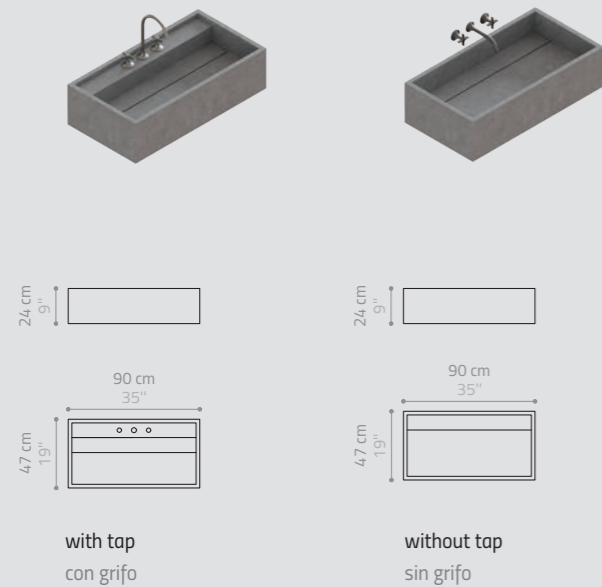

G.19 [90] with / without tap
G.19 [90] con / sin grifo

Equipped with
Accessible drain under removable piece
Desagüe accesible bajo pieza móvil

Combine with Furnitures
*Frame / Drawer / Line
*Frame+Line

***Special Dimensions for:**
G.19 [86] & Frame
G.19 [86] & Frame+Line

Packaging values
height altura 36 cm / 15"
width anchura 125 cm / 50"
depth profundidad 59 cm / 24"

with tap
con grifo

without tap
sin grifo

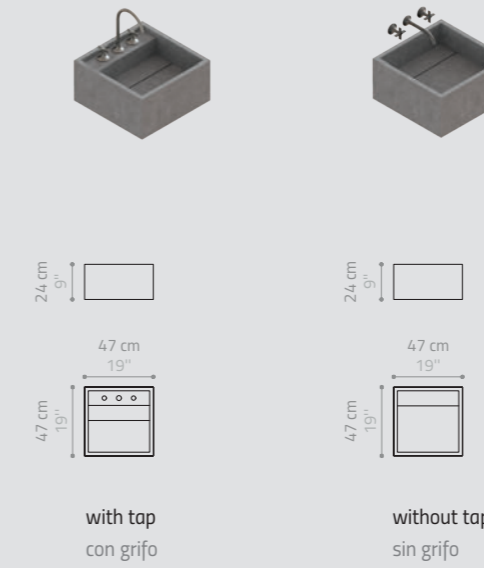

G.19 [47] with / without tap
G.19 [47] con / sin grifo

Equipped with
Accessible drain under removable piece
Desagüe accesible bajo pieza móvil

Combine with Furnitures
*Cabinet / *Frame
*Special Dimensions for:
G.19 [39] & Cabinet
G.19 [43] & Frame

Packaging values
height altura 36 cm / 14"
width anchura 82 cm / 33"
depth profundidad 59 cm / 24"

with tap
con grifo

without tap
sin grifo

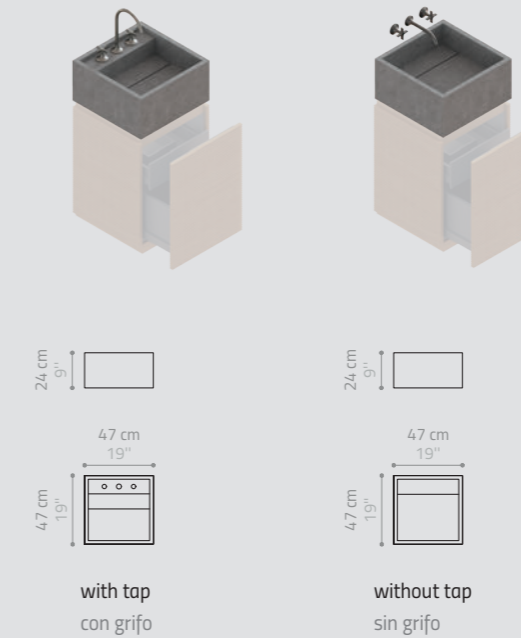

G.19 [47UN] with / without tap
G.19 [47UN] con / sin grifo

Only available with Unit Furniture
Sólo disponible junto a Mueble Unit

Equipped with
Accessible drain under removable piece
Desagüe accesible bajo pieza móvil

Packaging values
height altura 32 cm / 13"
width anchura 65 cm / 26"
depth profundidad 57 cm / 23"

with tap
con grifo

without tap
sin grifo



G.19 [47x90] Allure Grey
90x47x47cm
35"x19"x19"

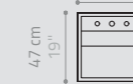
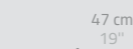

with tap
con grifo

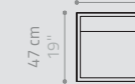
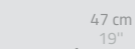

without tap
sin grifo

G.19 [47x90] with / without tap
G.19 [47x90] con / sin grifo

Equipped with
Accessible drain under removable piece
Desagüe accesible bajo pieza móvil

Packaging values
height altura 102 cm / 41"
width anchura 59 cm / 24"
depth profundidad 59 cm / 24"

TECHNICAL INFORMATION

64

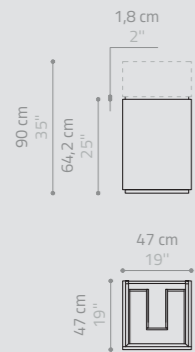
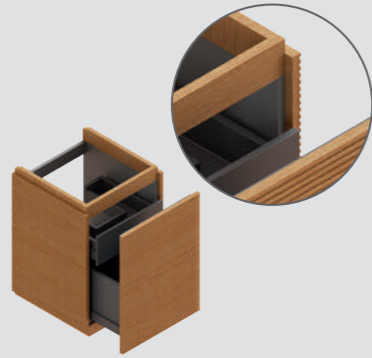

Unit Series

UNIT

Equipped with
2 Drawers / 2 Cajones
Combine with Basin
G19 [47 UN]
Packaging values
height altura 75 cm / 30"
width anchura 59 cm / 24"
depth profundidad 57 cm / 23"

Available Finishes

Ribbed / Shadow / Striped / Cross

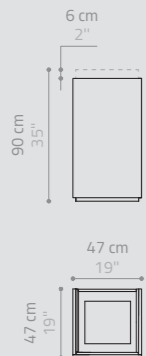
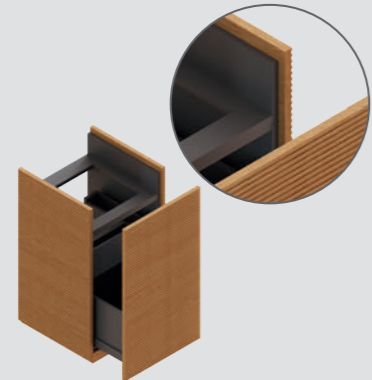

Cabinet Series

CABINET [47]

Equipped with
2 Drawers / 2 Cajones
Combine with Basin
G19
Packaging values
height altura 92 cm / 37"
width anchura 59 cm / 24"
depth profundidad 57 cm / 23"

Available Finishes

Ribbed / Shadow / Striped / Cross



Unit Series

65



G.19 [47 UN] Noon Grey Soft Textured Basin
Unit Ribbed Natural Oak
90x47x47 cm
35"x19"x19"



CABINET [240]

Equipped with
10 Drawers / 10 Cajones
Combine with Basin
G19 / A71
Packaging values
height altura 100 cm / 41"
width anchura 252 cm / 99"
depth profundidad 57 cm / 23"

Available Finishes

Ribbed / Shadow / Striped / Cross

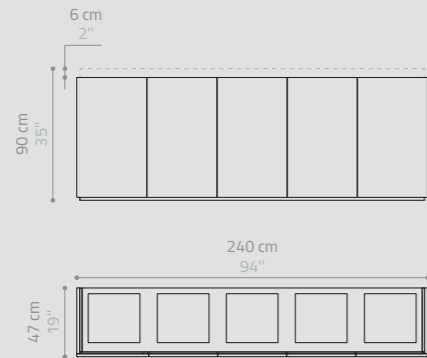

CABINET [180]

Equipped with
8 Drawers / 8 Cajones
Combine with Basin
G19 / A71
Packaging values
height altura 100 cm / 40"
width anchura 192 cm / 76"
depth profundidad 57 cm / 23"

Available Finishes

Ribbed / Shadow / Striped / Cross

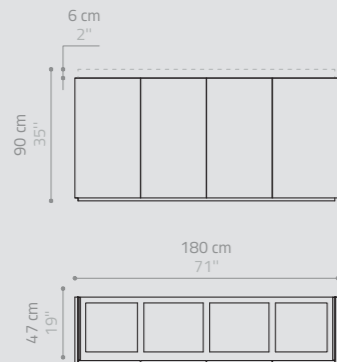

CABINET [120]

Equipped with
6 Drawers / 6 Cajones
Combine with Basin
G19 / A71
Packaging values
height altura 92 cm / 37"
width anchura 132 cm / 52"
depth profundidad 57 cm / 23"

Available Finishes

Ribbed / Shadow / Striped / Cross

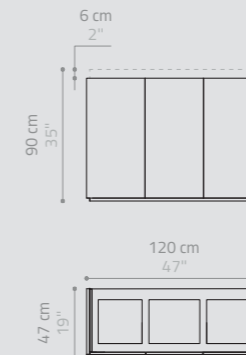

Frame Series

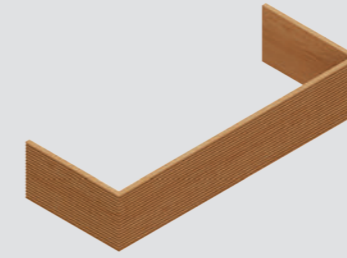

FRAME [240]

Combine with Basin
A71 / L28 / G19

Available Finishes

Ribbed / Shadow / Striped / Cross



Natural Oak Dark Oak Dry Oak



FRAME [120]

Combine with Basin
A71 / L28 / G19

Available Finishes

Ribbed / Shadow / Striped / Cross



Natural Oak Dark Oak Dry Oak

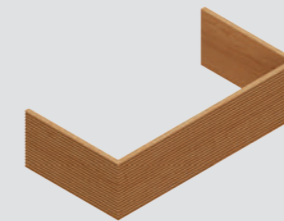
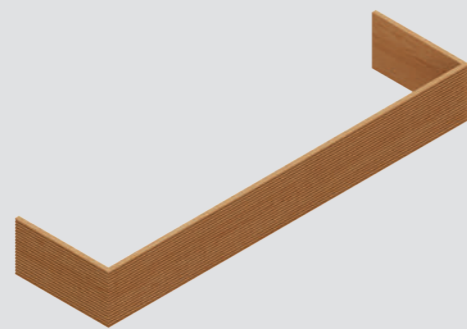
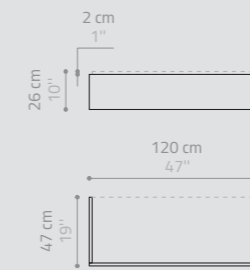

FRAME [180]

Combine with Basin
A71 / L28 / G19

Available Finishes

Ribbed / Shadow / Striped / Cross



Natural Oak Dark Oak Dry Oak

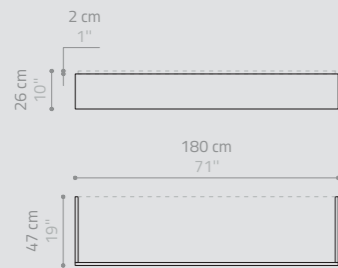

FRAME [90]

Combine with Basin
A71 / L28 / G19

Available Finishes

Ribbed / Shadow / Striped / Cross



Natural Oak Dark Oak Dry Oak

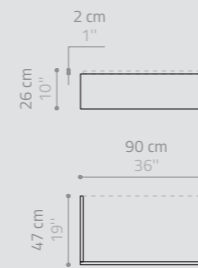

Drawer Series

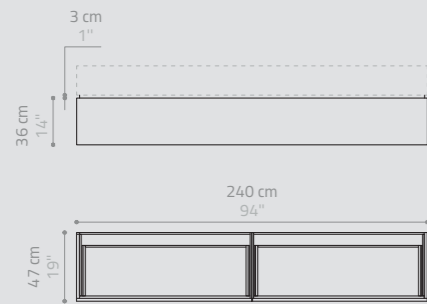
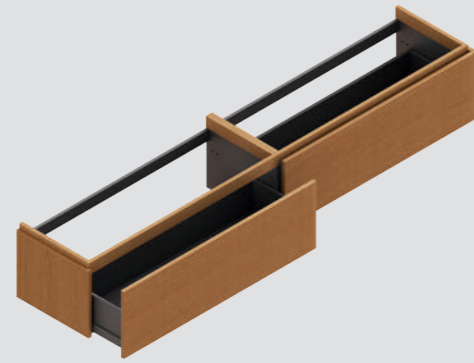

DRAWER [240]

Equipped with
2 Drawers / 2 Cajones
Combine with Basin
A71 / L28 / W37 / G19
Packaging values
height altura 55 cm / 22"
width anchura 252 cm / 100"
depth profundidad 57 cm / 23"

Available Finishes

Ribbed / Shadow / Striped / Cross

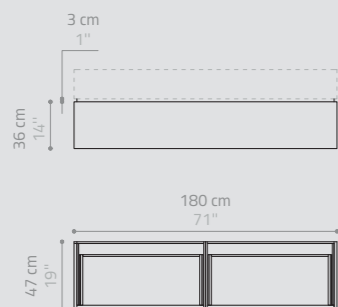

DRAWER [180]

Equipped with
2 Drawers / 2 Cajones
Combine with Basin
A71 / L28 / W37 / G19
Packaging values
height altura 55 cm / 22"
width anchura 192 cm / 76"
depth profundidad 57 cm / 23"

Available Finishes

Ribbed / Shadow / Striped / Cross

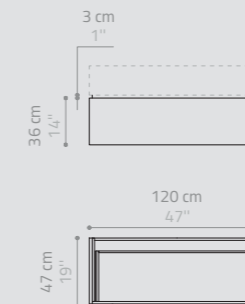

DRAWER [120]

Equipped with
1 Drawer / 1 Cajón
Combine with Basin
A71 / L28 / W37 / G19
Packaging values
height altura 47 cm / 19"
width anchura 132 cm / 52"
depth profundidad 57 cm / 23"

Available Finishes

Ribbed / Shadow / Striped / Cross

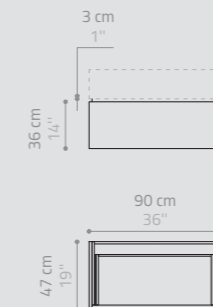

DRAWER [90]

Equipped with
1 Drawer / 1 Cajón
Combine with Basin
A71 / L28 / W37 / G19
Packaging values
height altura 47 cm / 19"
width anchura 102 cm / 40"
depth profundidad 57 cm / 23"

Available Finishes

Ribbed / Shadow / Striped / Cross



Line Series

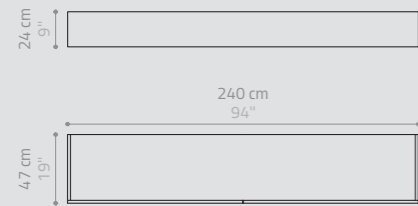

LINE [240]

Equipped with
2 Drawer / 2 Cajón
Combine with Basin
A71 / L28 / W37 / G19
Packaging values
height altura 42 cm / 17"
width anchura 252 cm / 100"
depth profundidad 57 cm / 23"

Available Finishes

Ribbed / Shadow / Striped / Cross



LINE [180]

Equipped with
2 Drawer / 2 Cajón
Combine with Basin
A71 / L28 / W37 / G19
Packaging values
height altura 42 cm / 17"
width anchura 192 cm / 76"
depth profundidad 57 cm / 23"

Available Finishes

Ribbed / Shadow / Striped / Cross

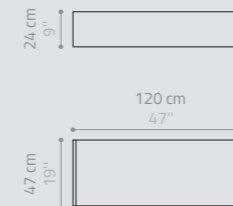

LINE [120]

Equipped with
1 Drawer / 1 Cajón
Combine with Basin
A71 / L28 / W37 / G19
Packaging values
height altura 34 cm / 14"
width anchura 132 cm / 52"
depth profundidad 57 cm / 23"

Available Finishes

Ribbed / Shadow / Striped / Cross

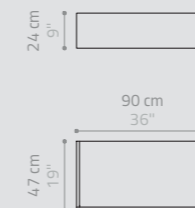

LINE [90]

Equipped with
1 Drawer / 1 Cajón
Combine with Basin
A71 / L28 / W37 / G19
Packaging values
height altura 34 cm / 14"
width anchura 102 cm / 40"
depth profundidad 57 cm / 23"

Available Finishes

Ribbed / Shadow / Striped / Cross





Livingceramics Production Center

CONSIDERATIONS

For the correct installation of bathroom furniture, it is recommended to reinforce the partition taking into account the approximate weights indicated in the following table:

CONSIDERACIONES PREVIAS

Para la correcta instalación de los muebles de baño, se recomienda reforzar el tabique teniendo en cuenta los pesos aproximados que se indican en la siguiente tabla:

Object Objeto	Length Longitud	Weight Approx. Peso Aproximado.
Ceramic Basin Lavabo Cerámico	240 cm.	150 Kg.
	180 cm.	115 Kg.
	120 cm.	80 Kg.
Auxiliar Furnitures Muebles Auxiliares	90 cm.	60 Kg.
	240 cm.	200 Kg.
	180 cm.	160 Kg.
	120 cm.	120 Kg.
	90 cm.	80 Kg.

TECHNICAL SPECIFICATIONS & MAINTENANCE

WOOD

The wooden bathroom units are made of solid oak, in a smudge-proof matt lacquer finish. Real oak has a high resistance to biological agents like fungi or insects. By using solid oak, the collection is assured a unique personality, and each unit stands out for its select appearance. Because this is real wood, in the long term it can undergo subtle changes in appearance through exposure to sunlight or other external agents. Consequently, precise uniform shades and continuous veined patterns cannot be guaranteed, and the wood might feature some knots. This is regarded to be an added value, since each unit will have a slightly distinctive end appearance, a unique facet of natural materials. The interiors are made of water-repellent top-quality MDF with an Anthracite-coloured wood veneer finish, ensuring a higher resistance to surface damage. The bathroom units stand out particularly for their imperviousness and resistance when used in wet areas. This makes them the perfect choice for indoor areas.

CERAMIC TILES

The ceramic washbasins in this ground-breaking collection are made of top-quality porcelain tiles, an optimum choice for bathrooms. This is a forward-looking material, both technologically and in product

design terms, thanks to technical properties as fundamental as its water absorption rate, durability and fire resistance. Its mechanical and thermal properties easily surpass the requirements of the relevant standards.

CARING FOR THE WASHBASINS AND BATHROOM UNITS

Ceramic washbasins and countertops, must be cleaned on a regular basis. They are swift and simple to clean, using just a moist microfibre cloth. Detergent can also be used, as per the amount indicated by the manufacturer. Take special care with all joints and follow the instructions of the manufacturer of the grouting material. To make the washbasins easier to clean, there is an opening in the underside, providing access to the channel where the drain is. This facilitates the fitting process and the cleaning of this concealed area. The drainage channel must be more carefully cleaned, using a damp cloth and, if appropriate, a detergent as described above.

To clean the wood units, use a soft moist cloth. Do not use detergent, wax, soap or other products. Dry the wood well afterwards to avoid stains or surface damage.

ESPECIFICACIONES TÉCNICAS Y MANTENIMIENTO

MADERA

Las piezas de mobiliario en acabado madera están fabricadas en roble macizo natural, presentando un lacado o acabado mate antihuella. La madera natural de roble presenta una alta resistencia a agentes biológicos, tales como hongos e insectos. La utilización de madera maciza confiere un carácter único a la colección, aportando un aspecto distinguido a cada pieza. Al ser una madera natural puede presentar a largo plazo una pequeña variación en su aspecto original debido a la exposición del sol u a otros agentes externos. Por este motivo, no se asegura una uniformidad precisa en las tonalidades de sus acabados, así como una continuidad en las vetas de la madera, pudiendo presentar nudos. Este aspecto se observa como un valor añadido, ya que el mueble tiene una estética final personal, característica única en los materiales naturales. El interior se fabrica con tableros de DM hidrófugo de alta calidad chapados en acabado Anthracite, asegurando una mejor resistencia con respecto a daños superficiales. Una de sus características más importantes es la impermeabilidad y resistencia a espacios húmedos, siendo un material de características óptimas para el espacio interior.

CERÁMICA

Los lavabos cerámicos están fabricados en gres porcelánico de primera calidad, presentando una colección innovadora utilizando un material óptimo para espacios de baño. El uso de dicho material representa un salto hacia el futuro en términos de tecnología

y planificación del producto. Se consiguen unas características técnicas perfectas en cuanto a absorción del agua, durabilidad y resistencia contra el fuego. El material presenta unas propiedades mecánicas y térmicas que representan una gran mejora sustancial con respecto a los requisitos exigidos por la normativa en vigor.

MANTENIMIENTO LAVABOS Y MOBILIARIO

Los lavabos y encimeras de cerámica de la marca deben tener una limpieza continuada, la cual puede ser sencilla y rápida. Sencillamente, se puede recurrir a un paño suave de microfibra húmedo, pudiendo utilizar detergentes con la dosis recomendada por el fabricante. Hay que tener especial cuidado con las juntas, por ello se recomienda seguir las indicaciones aportadas por el distribuidor de la marca de la junta elegida. Para una correcta limpieza, se ha diseñado una apertura en la parte inferior del lavabo, a través de la cual se accede al canal donde se ubica el desagüe. De esta forma, se facilita tanto la limpieza de dicha zona oculta, además de una fácil instalación. Dicha superficie o canal debe limpiarse con más asiduidad y cuidado, mediante una bayeta húmeda y recurriendo si se desea a algún detergente como anteriormente se ha definido.

Para la limpieza de los muebles de madera, se sugiere utilizar un paño suave y húmedo, evitando el uso de detergentes, ceras, jabones u otros productos. Se debe asegurar el secado completo de la madera para no provocar manchas o daños superficiales.

THE FOLLOWING GENERAL TERMS AND CONDITIONS GOVERN SALES BETWEEN Lvg Ceramic Surfaces, S.L. AND ITS CLIENTS.**1. Orders**

The parties' obligations concerning deliveries of goods (the transfer of responsibilities, expenses, insurance, customs procedures etc.) shall be those deriving from the agreed specific terms and conditions (INCOTERMS 2020). Barring possible agreed written amendments or exceptions, the general terms and conditions outlined herein shall regulate all sale agreements between our company and the buyer and hence both the contractual agreement that was reached on acceptance of this order and any future agreement for the supply of products by our company through successive different orders. Variations in the general sales conditions and in any sales offers, transactions, credit notes or discounts agreed upon by our Agents or by other intermediaries shall only be deemed to be valid once they have been accepted in writing by our head office and, in all such cases, this written acceptance shall only apply to the related agreement.

2. Supplies and deliveries of goods

On reception of a delivery of goods, the buyer shall immediately inspect them for flaws or defects. Lvg Ceramic Surfaces, S.L. must be given written notice of any external or visible flaws within

fifteen (15) days of the reception of the goods. In the case of hidden flaws, the deadline for claims shall be thirty (30) days from the reception of the goods. If no notice of any flaws is given by the buyer within the said deadlines, the latter shall be deemed to have approved the goods. The buyer of a faulty product must make a claim within the aforementioned stipulated period, opting for one of the following possible solutions:

1. The delivery of a new product in exchange for the return of the faulty one.
2. A refund of the price that was paid in exchange for the return of the faulty product.

The distributor shall be liable for attaching the warranty, technical specifications and product care instructions to the invoice given to the client.

3. Returns

Faulty goods must be returned in the same state and packaging in which they were received. Orders received directly from clients or placed on the latter's behalf by our representatives shall always be subject to our acceptance. The acceptance of a return by Lvg Ceramic Surfaces, S.L. does not mean that it admits or agrees to the claim for the faulty product. In the event of mistakes in the number of goods that are supplied, the buyer shall only be entitled to claim for the number that was not delivered. The

de reclamación será de treinta (30) días desde su recepción. Si el comprador no realiza notificación alguna de defectos en dichos plazos, la mercancía se considerará conforme. La parte compradora de una mercancía que se encuentre en estado defectuoso, como se ha indicado, debe reclamar en plazo y optar a las siguientes vías de solución:

1. La entrega de una mercancía nueva a cambio de la devolución de la defectuosa.
2. Reintegro del precio abonado a cambio de la de la devolución de la defectuosa.

Por otra parte, el distribuidor se responsabiliza de adjuntar en la factura que debe dar al cliente tanto la Garantía, como las especificaciones técnicas y mantenimiento del mueble.

3. Devolución

La mercancía defectuosa debe devolverse en el estado y con en el embalaje mediante el cual ha sido entregada. Los pedidos recibidos directamente de los clientes o realizados por nuestros representantes en nombre de ellos siempre estarán sujetos a nuestra aceptación. Se tiene en cuenta que la realización de una devolución aceptada por Lvg Ceramic Surfaces, S.L. no significa que se asuma o reconozca la reclamación debida a defectos en la mercancía. En caso de defectos en la cantidad suministrada, el comprador tendrá únicamente derecho a poder reclamar la cantidad no entregada. El responsable de la entrega del residuo

final recipient of the used packaging or packaging waste shall be responsible for its delivery to the appropriate environmental waste management service.

4. Deliveries

Goods delivered by Lvg Ceramic Surfaces, S.L. are subject to retention of title. The ownership of the goods shall only be transferred to the buyer when they have been fully paid for. Lvg Ceramic Surfaces, S.L. shall be entitled to offset any sum owed to it by the buyer against any sum payable by the company to the buyer. In the event of failure to comply with the conditions regarding the payment and/or return of the agreed goods, the buyer shall be liable for the cost of their return, plus any expenses of an administrative nature or costs derived from legal claims, including the fees of solicitors and court representatives. In the event of a delay in the payment of goods by the buyer, the seizure of the latter's goods or a substantial decline in the buyer's financial situation, Lvg Ceramic Surfaces, S.L. shall be entitled to claim immediate payment of the invoiced amount, to withhold all pending supplies and services, to condition the delivery of goods—once the buyer is no longer in arrears—upon their advance payment and, if applicable, to claim for any corresponding compensation. Under no circumstances may the goods be resold through a website (online sales). Unless agreed otherwise, the buyer shall be forbidden from exporting materials

de envase o envase usado para su correcta gestión ambiental será el poseedor final del mismo.

4. Entrega

Las mercancías entregadas por Lvg Ceramic Surfaces, S.L. están sujetas a reserva de dominio. La propiedad de la mercancía únicamente pasará al comprador en el momento en que esté completamente pagada. Lvg Ceramic Surfaces, S.L. tiene derecho a compensar cualquier suma que le adeude el comprador contra cualquier suma que resulte pagadera al comprador. En caso de incumplimiento de las condiciones de pago y/o devolución de los efectos negociados, serán de cuenta del comprador los gastos de devolución más los gastos de administración y reclamación judicial que se originen en su caso, incluidos los honorarios de letrados y procuradores. En caso de mora en el pago de la mercancía por el comprador, así como si sufriera embargo en sus bienes o si se produjera un empeoramiento sustancial de su situación patrimonial, Lvg Ceramic Surfaces, S.L. estará facultada para reclamar el pago inmediato del importe facturado y retener todos los suministros y prestaciones pendientes y condicionar la entrega de las mercaderías - aun cuando el comprador ya no se encuentre en mora - al pago por adelantado de las mismas así como, en su caso, a reclamar la indemnización correspondiente. En ningún caso la mercancía podrá ser objeto de reventa mediante el uso de una página web (venta online). Siempre que no existan acuerdos contrarios, se prohíbe al Comprador exportar los materiales que le

supplied by Lvg Ceramic Surfaces, S.L. and from making them available to companies or individuals who go on to export them.

5. Competent jurisdiction

The resulting relations between the parties shall be subject to the legislation of the Kingdom of Spain. Both parties expressly waive their right to any other corresponding jurisdiction and they agree to abide by the decisions of the Vila-real Law Courts (Castellón) in the settlement of any dispute, controversy or claim that might arise in connection with the said commercial relations.

6. Data protection

In accordance with Spanish Data Protection Act 15/1999 of December 13th, the personal data supplied by the buyer shall be entered in Lvg Ceramic Surfaces, S.L.'s client file for the purpose of managing contractual relations and controlling and managing sales and the corresponding collection of payment. Lvg Ceramic Surfaces, S.L. shall process the said data with all due confidentiality and it undertakes not to use the said information for any other purpose than that cited above. Likewise, it agrees to take the necessary steps to keep the data safe and to avoid its alteration, loss, and unauthorized access or processing. The buyer shall be entitled to exercise its right of access, rectification, cancellation and objection by giving written notice to Lvg Ceramic Surfaces, S.L..

suministre nuestra empresa, o cedérsela a empresas o personas que los exporten.

5. Tribunal competente

Las partes someten las relaciones resultantes entre las mismas a lo dispuesto en la Legislación del Reino de España y, con renuncia expresa al propio fuero que pudiera corresponderles, se someten a los juzgados y tribunales de Vila-real (Castellón) para resolver cualquier controversia, conflicto o reclamación que surja en conexión con la relación comercial establecida entre las mismas.

6. Protección de Datos de Carácter Personal

Conforme a la Ley Orgánica de 15/1999 de 13 de diciembre de Protección de Datos de Carácter Personal, los datos de carácter personal facilitados por el comprador formarán parte del fichero de clientes de Lvg Ceramic Surfaces, S.L., cuyos fines son el mantenimiento de la relación contractual, el control y gestión de las ventas y sus correspondientes cobros. Lvg Ceramic Surfaces, S.L. tratará dichos datos con la máxima confidencialidad, y se compromete a no utilizarlos con un fin distinto a aquel para el que han sido recabados, así como a conservarlos con las debidas medidas que garanticen su seguridad y eviten su alteración, pérdida, tratamiento o acceso no autorizados. El comprador tiene la posibilidad de ejercitar los derechos de acceso, rectificación, cancelación y oposición dirigiendo una comunicación por escrito a Lvg Ceramic Surfaces, S.L..

BATHROOM FURNITURE SERIES

2024 BATHROOM EDITION I
2024 BAÑOS EDICIÓN I

Livingceramics

Headquarters, Showroom and Warehouse

Oficinas, Showroom Y Almacén

Ctra. Vila-real – Onda CV 20 KM 2.5
12540, Vila-real, Castellón, Spain

Production Center

Centro De Producción

Ctra. Onda – Ribesalbes CV 191 KM 3
12200, Onda, Castellón, Spain

www.livingceramics.com
info@livingceramics.com

Tel. +34 964 914 181
Fax. +34 964 914 250



The taps, siphons and decorative elements present in the catalog images are not included and make up a proposal in the presentation of our products.

Los grifos, sifones y elementos decorativos presentes en las imágenes del catálogo no están incluidos y conforman una propuesta en la presentación de nuestros productos.

Legal Information
Información Legal

Lvg Ceramic Surfaces, S.L. reserves the right to make changes and modifications deemed necessary. Because of the printing process, the colors shown in this catalog are approximate, not exact. The information in this catalog is fully protected by copyright. Total or partial reproduction of text, illustrations, images and graphical representations is forbidden without the express permission of Livingceramics.

Lvg Ceramic Surfaces, S.L. se reserva el derecho de hacer variaciones y modificaciones que considere oportunas. A causa de los procesos de impresión, los colores que aparecen en este catálogo deben considerarse aproximados, no exactos. La información de este catálogo está protegida en su totalidad por copyright. Está prohibida la reproducción total o parcial de los textos, ilustraciones, imágenes y representaciones gráficas sin la autorización expresa de Livingceramics.

Now you know not only our materials, but the way we get there: technological innovation, high quality raw materials and a creative and meticulous design process. And therein lies the difference.

Ahora ya conoces no solo nuestros materiales, sino la forma en que llegamos a ellos: innovación tecnológica, alta calidad en las materias primas y un proceso de diseño creativo y minucioso. Y ahí está la diferencia.

Livingceramics